

18 ELECTRIC CHARGE AND ELECTRIC FIELD



Figure 18.1 Static electricity from this plastic slide causes the child's hair to stand on end. The sliding motion stripped electrons away from the child's body, leaving an excess of positive charges, which repel each other along each strand of hair. (credit: Ken Bosma/Wikimedia Commons)

Chapter Outline

18.1. Static Electricity and Charge: Conservation of Charge

- Define electric charge, and describe how the two types of charge interact.
- Describe three common situations that generate static electricity.
- State the law of conservation of charge.

18.2. Conductors and Insulators

- Define conductor and insulator, explain the difference, and give examples of each.
- Describe three methods for charging an object.
- Explain what happens to an electric force as you move farther from the source.
- Define polarization.

18.3. Coulomb's Law

- State Coulomb's law in terms of how the electrostatic force changes with the distance between two objects.
- Calculate the electrostatic force between two charged point forces, such as electrons or protons.
- Compare the electrostatic force to the gravitational attraction for a proton and an electron; for a human and the Earth.

18.4. Electric Field: Concept of a Field Revisited

- Describe a force field and calculate the strength of an electric field due to a point charge.
- Calculate the force exerted on a test charge by an electric field.
- Explain the relationship between electrical force (F) on a test charge and electrical field strength (E).

18.5. Electric Field Lines: Multiple Charges

- Calculate the total force (magnitude and direction) exerted on a test charge from more than one charge
- Describe an electric field diagram of a positive point charge; of a negative point charge with twice the magnitude of positive charge
- Draw the electric field lines between two points of the same charge; between two points of opposite charge.

18.6. Electric Forces in Biology

- Describe how a water molecule is polar.
- Explain electrostatic screening by a water molecule within a living cell.

18.7. Conductors and Electric Fields in Static Equilibrium

- List the three properties of a conductor in electrostatic equilibrium.
- Explain the effect of an electric field on free charges in a conductor.
- Explain why no electric field may exist inside a conductor.
- Describe the electric field surrounding Earth.
- Explain what happens to an electric field applied to an irregular conductor.

- Describe how a lightning rod works.
- Explain how a metal car may protect passengers inside from the dangerous electric fields caused by a downed line touching the car.

18.8. Applications of Electrostatics

- Name several real-world applications of the study of electrostatics.

Introduction to Electric Charge and Electric Field

The image of American politician and scientist Benjamin Franklin (1706–1790) flying a kite in a thunderstorm is familiar to every schoolchild. (See **Figure 18.2**.) In this experiment, Franklin demonstrated a connection between lightning and **static electricity**. Sparks were drawn from a key hung on a kite string during an electrical storm. These sparks were like those produced by static electricity, such as the spark that jumps from your finger to a metal doorknob after you walk across a wool carpet. What Franklin demonstrated in his dangerous experiment was a connection between phenomena on two different scales: one the grand power of an electrical storm, the other an effect of more human proportions. Connections like this one reveal the underlying unity of the laws of nature, an aspect we humans find particularly appealing.

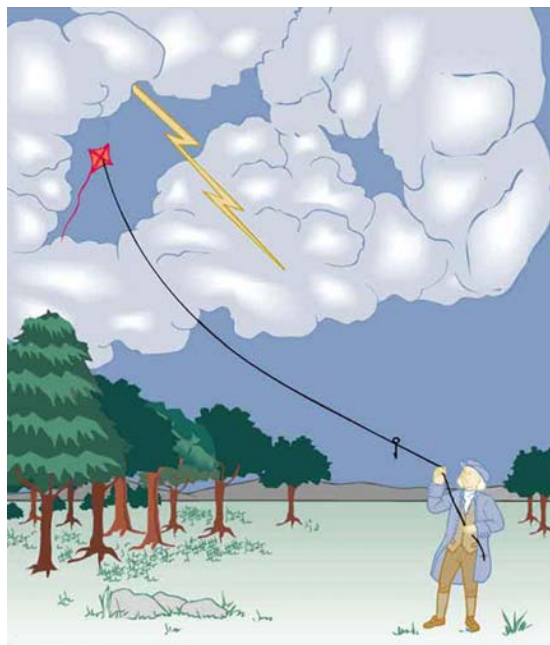

Figure 18.2 When Benjamin Franklin demonstrated that lightning was related to static electricity, he made a connection that is now part of the evidence that all directly experienced forces except the gravitational force are manifestations of the electromagnetic force.

Much has been written about Franklin. His experiments were only part of the life of a man who was a scientist, inventor, revolutionary, statesman, and writer. Franklin's experiments were not performed in isolation, nor were they the only ones to reveal connections.

For example, the Italian scientist Luigi Galvani (1737–1798) performed a series of experiments in which static electricity was used to stimulate contractions of leg muscles of dead frogs, an effect already known in humans subjected to static discharges. But Galvani also found that if he joined two metal wires (say copper and zinc) end to end and touched the other ends to muscles, he produced the same effect in frogs as static discharge. Alessandro Volta (1745–1827), partly inspired by Galvani's work, experimented with various combinations of metals and developed the battery.

During the same era, other scientists made progress in discovering fundamental connections. The periodic table was developed as the systematic properties of the elements were discovered. This influenced the development and refinement of the concept of atoms as the basis of matter. Such submicroscopic descriptions of matter also help explain a great deal more.

Atomic and molecular interactions, such as the forces of friction, cohesion, and adhesion, are now known to be manifestations of the **electromagnetic force**. Static electricity is just one aspect of the electromagnetic force, which also includes moving electricity and magnetism.

All the macroscopic forces that we experience directly, such as the sensations of touch and the tension in a rope, are due to the electromagnetic force, one of the four fundamental forces in nature. The gravitational force, another fundamental force, is actually sensed through the electromagnetic interaction of molecules, such as between those in our feet and those on the top of a bathroom scale. (The other two fundamental forces, the strong nuclear force and the weak nuclear force, cannot be sensed on the human scale.)

This chapter begins the study of electromagnetic phenomena at a fundamental level. The next several chapters will cover static electricity, moving electricity, and magnetism—collectively known as electromagnetism. In this chapter, we begin with the study of electric phenomena due to charges that are at least temporarily stationary, called electrostatics, or static electricity.

18.1 Static Electricity and Charge: Conservation of Charge



Figure 18.3 Borneo amber was mined in Sabah, Malaysia, from shale-sandstone-mudstone veins. When a piece of amber is rubbed with a piece of silk, the amber gains more electrons, giving it a net negative charge. At the same time, the silk, having lost electrons, becomes positively charged. (credit: Sebakoamber, Wikimedia Commons)

What makes plastic wrap cling? Static electricity. Not only are applications of static electricity common these days, its existence has been known since ancient times. The first record of its effects dates to ancient Greeks who noted more than 500 years B.C. that polishing amber temporarily enabled it to attract bits of straw (see **Figure 18.3**). The very word *electric* derives from the Greek word for amber (*electron*).

Many of the characteristics of static electricity can be explored by rubbing things together. Rubbing creates the spark you get from walking across a wool carpet, for example. Static cling generated in a clothes dryer and the attraction of straw to recently polished amber also result from rubbing. Similarly, lightning results from air movements under certain weather conditions. You can also rub a balloon on your hair, and the static electricity created can then make the balloon cling to a wall. We also have to be cautious of static electricity, especially in dry climates. When we pump gasoline, we are warned to discharge ourselves (after sliding across the seat) on a metal surface before grabbing the gas nozzle. Attendants in hospital operating rooms must wear booties with aluminum foil on the bottoms to avoid creating sparks which may ignite the oxygen being used.

Some of the most basic characteristics of static electricity include:

- The effects of static electricity are explained by a physical quantity not previously introduced, called electric charge.
- There are only two types of charge, one called positive and the other called negative.
- Like charges repel, whereas unlike charges attract.
- The force between charges decreases with distance.

How do we know there are two types of **electric charge**? When various materials are rubbed together in controlled ways, certain combinations of materials always produce one type of charge on one material and the opposite type on the other. By convention, we call one type of charge “positive”, and the other type “negative.” For example, when glass is rubbed with silk, the glass becomes positively charged and the silk negatively charged. Since the glass and silk have opposite charges, they attract one another like clothes that have rubbed together in a dryer. Two glass rods rubbed with silk in this manner will repel one another, since each rod has positive charge on it. Similarly, two silk cloths so rubbed will repel, since both cloths have negative charge.

Figure 18.4 shows how these simple materials can be used to explore the nature of the force between charges.

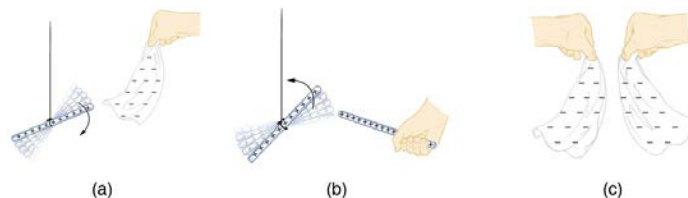

Figure 18.4 A glass rod becomes positively charged when rubbed with silk, while the silk becomes negatively charged. (a) The glass rod is attracted to the silk because their charges are opposite. (b) Two similarly charged glass rods repel. (c) Two similarly charged silk cloths repel.

More sophisticated questions arise. Where do these charges come from? Can you create or destroy charge? Is there a smallest unit of charge? Exactly how does the force depend on the amount of charge and the distance between charges? Such questions obviously occurred to Benjamin Franklin and other early researchers, and they interest us even today.

Charge Carried by Electrons and Protons

Franklin wrote in his letters and books that he could see the effects of electric charge but did not understand what caused the phenomenon. Today we have the advantage of knowing that normal matter is made of atoms, and that atoms contain positive and negative charges, usually in equal amounts.

Figure 18.5 shows a simple model of an atom with negative **electrons** orbiting its positive nucleus. The nucleus is positive due to the presence of positively charged **protons**. Nearly all charge in nature is due to electrons and protons, which are two of the

three building blocks of most matter. (The third is the neutron, which is neutral, carrying no charge.) Other charge-carrying particles are observed in cosmic rays and nuclear decay, and are created in particle accelerators. All but the electron and proton survive only a short time and are quite rare by comparison.

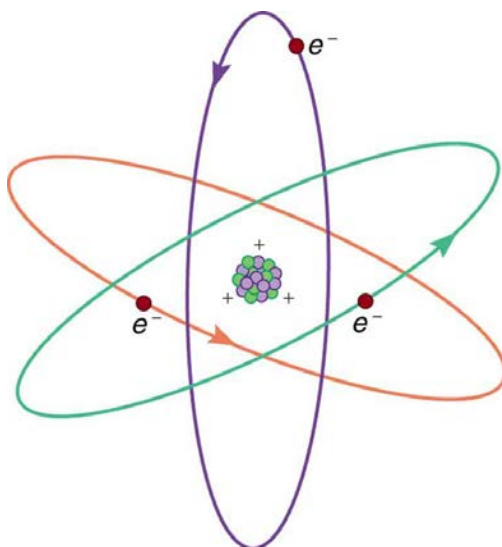

Figure 18.5 This simplified (and not to scale) view of an atom is called the planetary model of the atom. Negative electrons orbit a much heavier positive nucleus, as the planets orbit the much heavier sun. There the similarity ends, because forces in the atom are electromagnetic, whereas those in the planetary system are gravitational. Normal macroscopic amounts of matter contain immense numbers of atoms and molecules and, hence, even greater numbers of individual negative and positive charges.

The charges of electrons and protons are identical in magnitude but opposite in sign. Furthermore, all charged objects in nature are integral multiples of this basic quantity of charge, meaning that all charges are made of combinations of a basic unit of charge. Usually, charges are formed by combinations of electrons and protons. The magnitude of this basic charge is

$$|q_e| = 1.60 \times 10^{-19} \text{ C}. \quad (18.1)$$

The symbol q is commonly used for charge and the subscript e indicates the charge of a single electron (or proton).

The SI unit of charge is the coulomb (C). The number of protons needed to make a charge of 1.00 C is

$$1.00 \text{ C} \times \frac{1 \text{ proton}}{1.60 \times 10^{-19} \text{ C}} = 6.25 \times 10^{18} \text{ protons}. \quad (18.2)$$

Similarly, 6.25×10^{18} electrons have a combined charge of -1.00 coulomb. Just as there is a smallest bit of an element (an atom), there is a smallest bit of charge. There is no directly observed charge smaller than $|q_e|$ (see **Things Great and Small: The Submicroscopic Origin of Charge**), and all observed charges are integral multiples of $|q_e|$.

Things Great and Small: The Submicroscopic Origin of Charge

With the exception of exotic, short-lived particles, all charge in nature is carried by electrons and protons. Electrons carry the charge we have named negative. Protons carry an equal-magnitude charge that we call positive. (See **Figure 18.6**.) Electron and proton charges are considered fundamental building blocks, since all other charges are integral multiples of those carried by electrons and protons. Electrons and protons are also two of the three fundamental building blocks of ordinary matter. The neutron is the third and has zero total charge.

Figure 18.6 shows a person touching a Van de Graaff generator and receiving excess positive charge. The expanded view of a hair shows the existence of both types of charges but an excess of positive. The repulsion of these positive like charges causes the strands of hair to repel other strands of hair and to stand up. The further blowup shows an artist's conception of an electron and a proton perhaps found in an atom in a strand of hair.

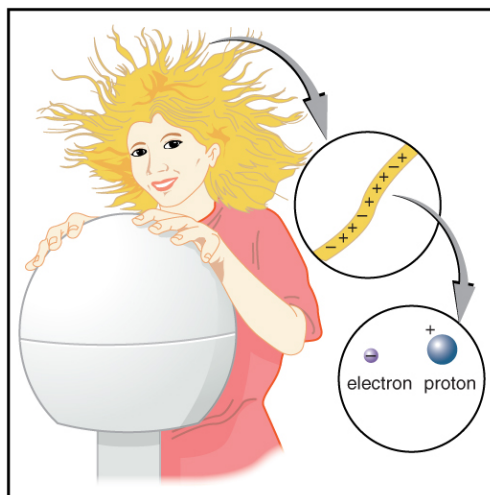

Figure 18.6 When this person touches a Van de Graaff generator, she receives an excess of positive charge, causing her hair to stand on end. The charges in one hair are shown. An artist's conception of an electron and a proton illustrate the particles carrying the negative and positive charges. We cannot really see these particles with visible light because they are so small (the electron seems to be an infinitesimal point), but we know a great deal about their measurable properties, such as the charges they carry.

The electron seems to have no substructure; in contrast, when the substructure of protons is explored by scattering extremely energetic electrons from them, it appears that there are point-like particles inside the proton. These sub-particles, named quarks, have never been directly observed, but they are believed to carry fractional charges as seen in **Figure 18.7**. Charges on electrons and protons and all other directly observable particles are unitary, but these quark substructures carry charges of either $-\frac{1}{3}$ or $+\frac{2}{3}$. There are continuing attempts to observe fractional charge directly and to learn of the properties of quarks, which are perhaps the ultimate substructure of matter.

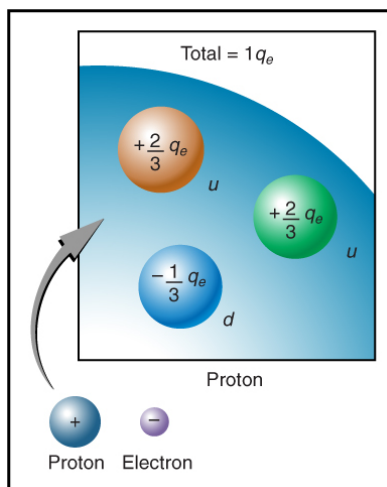

Figure 18.7 Artist's conception of fractional quark charges inside a proton. A group of three quark charges add up to the single positive charge on the proton: $-\frac{1}{3}q_e + \frac{2}{3}q_e + \frac{2}{3}q_e = +1q_e$.

Separation of Charge in Atoms

Charges in atoms and molecules can be separated—for example, by rubbing materials together. Some atoms and molecules have a greater affinity for electrons than others and will become negatively charged by close contact in rubbing, leaving the other material positively charged. (See **Figure 18.8**.) Positive charge can similarly be induced by rubbing. Methods other than rubbing can also separate charges. Batteries, for example, use combinations of substances that interact in such a way as to separate charges. Chemical interactions may transfer negative charge from one substance to the other, making one battery terminal negative and leaving the first one positive.

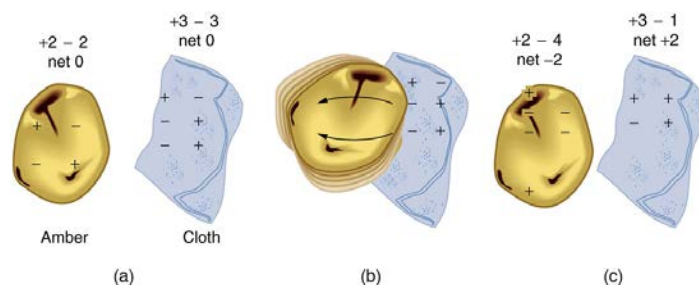

Figure 18.8 When materials are rubbed together, charges can be separated, particularly if one material has a greater affinity for electrons than another. (a) Both the amber and cloth are originally neutral, with equal positive and negative charges. Only a tiny fraction of the charges are involved, and only a few of them are shown here. (b) When rubbed together, some negative charge is transferred to the amber, leaving the cloth with a net positive charge. (c) When separated, the amber and cloth now have net charges, but the absolute value of the net positive and negative charges will be equal.

No charge is actually created or destroyed when charges are separated as we have been discussing. Rather, existing charges are moved about. In fact, in all situations the total amount of charge is always constant. This universally obeyed law of nature is called the **law of conservation of charge**.

Law of Conservation of Charge

Total charge is constant in any process.

In more exotic situations, such as in particle accelerators, mass, Δm , can be created from energy in the amount $\Delta m = \frac{E}{c^2}$.

Sometimes, the created mass is charged, such as when an electron is created. Whenever a charged particle is created, another having an opposite charge is always created along with it, so that the total charge created is zero. Usually, the two particles are “matter-antimatter” counterparts. For example, an antielectron would usually be created at the same time as an electron. The antielectron has a positive charge (it is called a positron), and so the total charge created is zero. (See **Figure 18.9**.) All particles have antimatter counterparts with opposite signs. When matter and antimatter counterparts are brought together, they completely annihilate one another. By annihilate, we mean that the mass of the two particles is converted to energy E , again obeying the relationship $\Delta m = \frac{E}{c^2}$. Since the two particles have equal and opposite charge, the total charge is zero before and after the annihilation; thus, total charge is conserved.

Making Connections: Conservation Laws

Only a limited number of physical quantities are universally conserved. Charge is one—energy, momentum, and angular momentum are others. Because they are conserved, these physical quantities are used to explain more phenomena and form more connections than other, less basic quantities. We find that conserved quantities give us great insight into the rules followed by nature and hints to the organization of nature. Discoveries of conservation laws have led to further discoveries, such as the weak nuclear force and the quark substructure of protons and other particles.

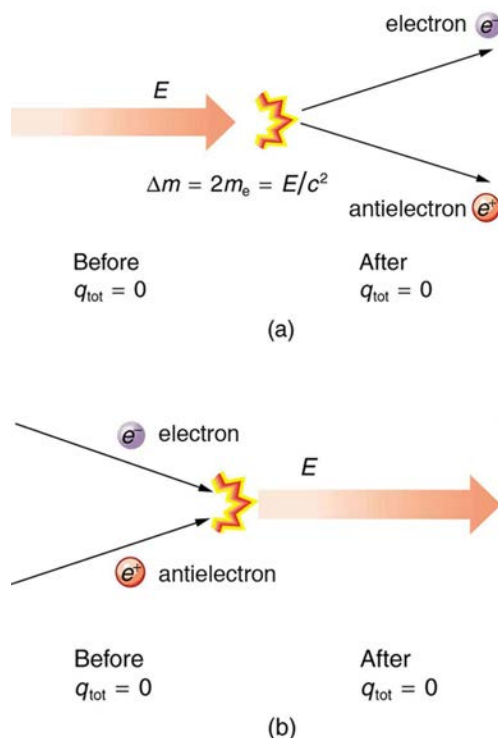

Figure 18.9 (a) When enough energy is present, it can be converted into matter. Here the matter created is an electron–antielectron pair. (m_e is the electron's mass.) The total charge before and after this event is zero. (b) When matter and antimatter collide, they annihilate each other; the total charge is conserved at zero before and after the annihilation.

The law of conservation of charge is absolute—it has never been observed to be violated. Charge, then, is a special physical quantity, joining a very short list of other quantities in nature that are always conserved. Other conserved quantities include energy, momentum, and angular momentum.

PhET Explorations: Balloons and Static Electricity

Why does a balloon stick to your sweater? Rub a balloon on a sweater, then let go of the balloon and it flies over and sticks to the sweater. View the charges in the sweater, balloons, and the wall.



PhET Interactive Simulation

Figure 18.10 Balloons and Static Electricity (http://cnx.org/content/m42300/1.5/balloons_en.jar)

18.2 Conductors and Insulators



Figure 18.11 This power adapter uses metal wires and connectors to conduct electricity from the wall socket to a laptop computer. The conducting wires allow electrons to move freely through the cables, which are shielded by rubber and plastic. These materials act as insulators that don't allow electric charge to escape outward. (credit: Evan-Amos, Wikimedia Commons)

Some substances, such as metals and salty water, allow charges to move through them with relative ease. Some of the electrons in metals and similar conductors are not bound to individual atoms or sites in the material. These **free electrons** can

move through the material much as air moves through loose sand. Any substance that has free electrons and allows charge to move relatively freely through it is called a **conductor**. The moving electrons may collide with fixed atoms and molecules, losing some energy, but they can move in a conductor. Superconductors allow the movement of charge without any loss of energy. Salty water and other similar conducting materials contain free ions that can move through them. An ion is an atom or molecule having a positive or negative (nonzero) total charge. In other words, the total number of electrons is not equal to the total number of protons.

Other substances, such as glass, do not allow charges to move through them. These are called **insulators**. Electrons and ions in insulators are bound in the structure and cannot move easily—as much as 10^{23} times more slowly than in conductors. Pure water and dry table salt are insulators, for example, whereas molten salt and salty water are conductors.

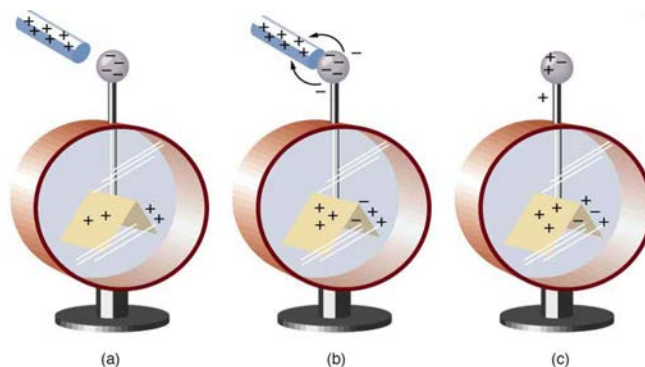

Figure 18.12 An electroscope is a favorite instrument in physics demonstrations and student laboratories. It is typically made with gold foil leaves hung from a (conducting) metal stem and is insulated from the room air in a glass-walled container. (a) A positively charged glass rod is brought near the tip of the electroscope, attracting electrons to the top and leaving a net positive charge on the leaves. Like charges in the light flexible gold leaves repel, separating them. (b) When the rod is touched against the ball, electrons are attracted and transferred, reducing the net charge on the glass rod but leaving the electroscope positively charged. (c) The excess charges are evenly distributed in the stem and leaves of the electroscope once the glass rod is removed.

Charging by Contact

Figure 18.12 shows an electroscope being charged by touching it with a positively charged glass rod. Because the glass rod is an insulator, it must actually touch the electroscope to transfer charge to or from it. (Note that the extra positive charges reside on the surface of the glass rod as a result of rubbing it with silk before starting the experiment.) Since only electrons move in metals, we see that they are attracted to the top of the electroscope. There, some are transferred to the positive rod by touch, leaving the electroscope with a net positive charge.

Electrostatic repulsion in the leaves of the charged electroscope separates them. The electrostatic force has a horizontal component that results in the leaves moving apart as well as a vertical component that is balanced by the gravitational force. Similarly, the electroscope can be negatively charged by contact with a negatively charged object.

Charging by Induction

It is not necessary to transfer excess charge directly to an object in order to charge it. **Figure 18.13** shows a method of **induction** wherein a charge is created in a nearby object, without direct contact. Here we see two neutral metal spheres in contact with one another but insulated from the rest of the world. A positively charged rod is brought near one of them, attracting negative charge to that side, leaving the other sphere positively charged.

This is an example of induced **polarization** of neutral objects. Polarization is the separation of charges in an object that remains neutral. If the spheres are now separated (before the rod is pulled away), each sphere will have a net charge. Note that the object closest to the charged rod receives an opposite charge when charged by induction. Note also that no charge is removed from the charged rod, so that this process can be repeated without depleting the supply of excess charge.

Another method of charging by induction is shown in **Figure 18.14**. The neutral metal sphere is polarized when a charged rod is brought near it. The sphere is then grounded, meaning that a conducting wire is run from the sphere to the ground. Since the earth is large and most ground is a good conductor, it can supply or accept excess charge easily. In this case, electrons are attracted to the sphere through a wire called the ground wire, because it supplies a conducting path to the ground. The ground connection is broken before the charged rod is removed, leaving the sphere with an excess charge opposite to that of the rod. Again, an opposite charge is achieved when charging by induction and the charged rod loses none of its excess charge.

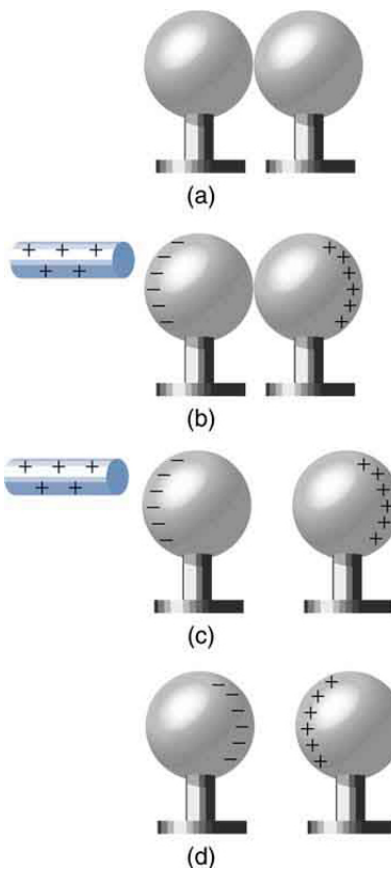

Figure 18.13 Charging by induction. (a) Two uncharged or neutral metal spheres are in contact with each other but insulated from the rest of the world. (b) A positively charged glass rod is brought near the sphere on the left, attracting negative charge and leaving the other sphere positively charged. (c) The spheres are separated before the rod is removed, thus separating negative and positive charge. (d) The spheres retain net charges after the inducing rod is removed—without ever having been touched by a charged object.

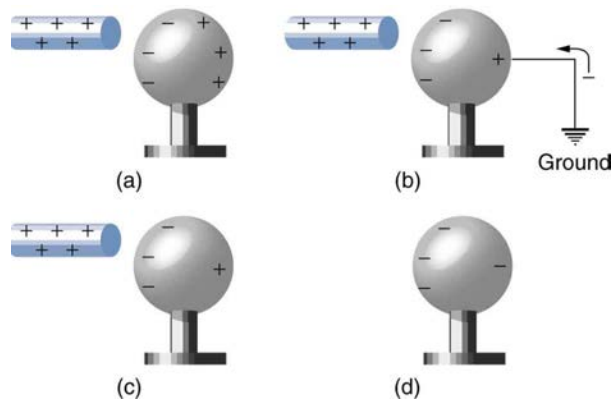

Figure 18.14 Charging by induction, using a ground connection. (a) A positively charged rod is brought near a neutral metal sphere, polarizing it. (b) The sphere is grounded, allowing electrons to be attracted from the earth's ample supply. (c) The ground connection is broken. (d) The positive rod is removed, leaving the sphere with an induced negative charge.

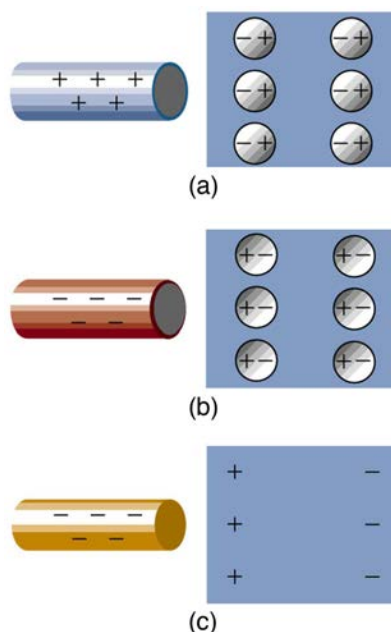

Figure 18.15 Both positive and negative objects attract a neutral object by polarizing its molecules. (a) A positive object brought near a neutral insulator polarizes its molecules. There is a slight shift in the distribution of the electrons orbiting the molecule, with unlike charges being brought nearer and like charges moved away. Since the electrostatic force decreases with distance, there is a net attraction. (b) A negative object produces the opposite polarization, but again attracts the neutral object. (c) The same effect occurs for a conductor; since the unlike charges are closer, there is a net attraction.

Neutral objects can be attracted to any charged object. The pieces of straw attracted to polished amber are neutral, for example. If you run a plastic comb through your hair, the charged comb can pick up neutral pieces of paper. **Figure 18.15** shows how the polarization of atoms and molecules in neutral objects results in their attraction to a charged object.

When a charged rod is brought near a neutral substance, an insulator in this case, the distribution of charge in atoms and molecules is shifted slightly. Opposite charge is attracted nearer the external charged rod, while like charge is repelled. Since the electrostatic force decreases with distance, the repulsion of like charges is weaker than the attraction of unlike charges, and so there is a net attraction. Thus a positively charged glass rod attracts neutral pieces of paper, as will a negatively charged rubber rod. Some molecules, like water, are polar molecules. Polar molecules have a natural or inherent separation of charge, although they are neutral overall. Polar molecules are particularly affected by other charged objects and show greater polarization effects than molecules with naturally uniform charge distributions.

Check Your Understanding

Can you explain the attraction of water to the charged rod in the figure below?

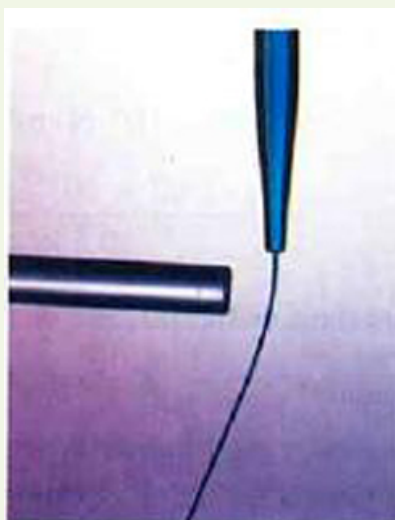

Figure 18.16

Solution

Water molecules are polarized, giving them slightly positive and slightly negative sides. This makes water even more susceptible to a charged rod's attraction. As the water flows downward, due to the force of gravity, the charged conductor exerts a net attraction to the opposite charges in the stream of water, pulling it closer.

PhET Explorations: John Travoltage

Make sparks fly with John Travoltage. Wiggle Johnnie's foot and he picks up charges from the carpet. Bring his hand close to the door knob and get rid of the excess charge.



PhET Interactive Simulation

Figure 18.17 John Travoltage (http://cnx.org/content/m42306/1.4/travoltage_en.jar)

18.3 Coulomb's Law



Figure 18.18 This NASA image of Arp 87 shows the result of a strong gravitational attraction between two galaxies. In contrast, at the subatomic level, the electrostatic attraction between two objects, such as an electron and a proton, is far greater than their mutual attraction due to gravity. (credit: NASA/HST)

Through the work of scientists in the late 18th century, the main features of the **electrostatic force**—the existence of two types of charge, the observation that like charges repel, unlike charges attract, and the decrease of force with distance—were eventually refined, and expressed as a mathematical formula. The mathematical formula for the electrostatic force is called **Coulomb's law** after the French physicist Charles Coulomb (1736–1806), who performed experiments and first proposed a formula to calculate it.

Coulomb's Law

$$F = k \frac{|q_1 q_2|}{r^2} \quad (18.3)$$

Coulomb's law calculates the magnitude of the force F between two point charges, q_1 and q_2 , separated by a distance r . In SI units, the constant k is equal to

$$k = 8.988 \times 10^9 \frac{\text{N} \cdot \text{m}^2}{\text{C}^2} \approx 8.99 \times 10^9 \frac{\text{N} \cdot \text{m}^2}{\text{C}^2} \quad (18.4)$$

The electrostatic force is a vector quantity and is expressed in units of newtons. The force is understood to be along the line joining the two charges. (See **Figure 18.19**.)

Although the formula for Coulomb's law is simple, it was no mean task to prove it. The experiments Coulomb did, with the primitive equipment then available, were difficult. Modern experiments have verified Coulomb's law to great precision. For example, it has been shown that the force is inversely proportional to distance between two objects squared ($F \propto 1/r^2$) to an accuracy of 1 part in 10^{16} . No exceptions have ever been found, even at the small distances within the atom.

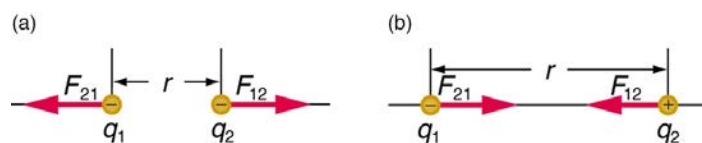

Figure 18.19 The magnitude of the electrostatic force F between point charges q_1 and q_2 separated by a distance r is given by Coulomb's law. Note that Newton's third law (every force exerted creates an equal and opposite force) applies as usual—the force on q_1 is equal in magnitude and opposite in direction to the force it exerts on q_2 . (a) Like charges. (b) Unlike charges.

Example 18.1 How Strong is the Coulomb Force Relative to the Gravitational Force?

Compare the electrostatic force between an electron and proton separated by 0.530×10^{-10} m with the gravitational force between them. This distance is their average separation in a hydrogen atom.

Strategy

To compare the two forces, we first compute the electrostatic force using Coulomb's law, $F = k \frac{|q_1 q_2|}{r^2}$. We then calculate the gravitational force using Newton's universal law of gravitation. Finally, we take a ratio to see how the forces compare in magnitude.

Solution

Entering the given and known information about the charges and separation of the electron and proton into the expression of Coulomb's law yields

$$F = k \frac{|q_1 q_2|}{r^2} \quad (18.5)$$

$$= (8.99 \times 10^9 \text{ N} \cdot \text{m}^2 / \text{C}^2) \times \frac{(1.60 \times 10^{-19} \text{ C})(1.60 \times 10^{-19} \text{ C})}{(0.530 \times 10^{-10} \text{ m})^2} \quad (18.6)$$

Thus the Coulomb force is

$$F = 8.19 \times 10^{-8} \text{ N}. \quad (18.7)$$

The charges are opposite in sign, so this is an attractive force. This is a very large force for an electron—it would cause an acceleration of $8.99 \times 10^{22} \text{ m/s}^2$ (verification is left as an end-of-section problem). The gravitational force is given by Newton's law of gravitation as:

$$F_G = G \frac{mM}{r^2}, \quad (18.8)$$

where $G = 6.67 \times 10^{-11} \text{ N} \cdot \text{m}^2 / \text{kg}^2$. Here m and M represent the electron and proton masses, which can be found in the appendices. Entering values for the knowns yields

$$F_G = (6.67 \times 10^{-11} \text{ N} \cdot \text{m}^2 / \text{kg}^2) \times \frac{(9.11 \times 10^{-31} \text{ kg})(1.67 \times 10^{-27} \text{ kg})}{(0.530 \times 10^{-10} \text{ m})^2} = 3.61 \times 10^{-47} \text{ N} \quad (18.9)$$

This is also an attractive force, although it is traditionally shown as positive since gravitational force is always attractive. The ratio of the magnitude of the electrostatic force to gravitational force in this case is, thus,

$$\frac{F}{F_G} = 2.27 \times 10^{39}. \quad (18.10)$$

Discussion

This is a remarkably large ratio! Note that this will be the ratio of electrostatic force to gravitational force for an electron and a proton at any distance (taking the ratio before entering numerical values shows that the distance cancels). This ratio gives some indication of just how much larger the Coulomb force is than the gravitational force between two of the most common particles in nature.

As the example implies, gravitational force is completely negligible on a small scale, where the interactions of individual charged particles are important. On a large scale, such as between the Earth and a person, the reverse is true. Most objects are nearly electrically neutral, and so attractive and repulsive **Coulomb forces** nearly cancel. Gravitational force on a large scale dominates interactions between large objects because it is always attractive, while Coulomb forces tend to cancel.

18.4 Electric Field: Concept of a Field Revisited

Contact forces, such as between a baseball and a bat, are explained on the small scale by the interaction of the charges in atoms and molecules in close proximity. They interact through forces that include the **Coulomb force**. Action at a distance is a force between objects that are not close enough for their atoms to “touch.” That is, they are separated by more than a few atomic diameters.

For example, a charged rubber comb attracts neutral bits of paper from a distance via the Coulomb force. It is very useful to think of an object being surrounded in space by a **force field**. The force field carries the force to another object (called a test object) some distance away.

Concept of a Field

A field is a way of conceptualizing and mapping the force that surrounds any object and acts on another object at a distance without apparent physical connection. For example, the gravitational field surrounding the earth (and all other masses) represents the gravitational force that would be experienced if another mass were placed at a given point within the field.

In the same way, the Coulomb force field surrounding any charge extends throughout space. Using Coulomb's law, $F = k|q_1q_2|/r^2$, its magnitude is given by the equation $F = k|qQ|/r^2$, for a **point charge** (a particle having a charge Q) acting on a **test charge** q at a distance r (see **Figure 18.20**). Both the magnitude and direction of the Coulomb force field depend on Q and the test charge q .

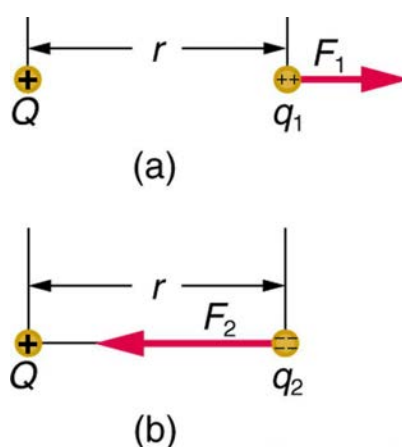

Figure 18.20 The Coulomb force field due to a positive charge Q is shown acting on two different charges. Both charges are the same distance from Q . (a) Since q_1 is positive, the force F_1 acting on it is repulsive. (b) The charge q_2 is negative and greater in magnitude than q_1 , and so the force F_2 acting on it is attractive and stronger than F_1 . The Coulomb force field is thus not unique at any point in space, because it depends on the test charges q_1 and q_2 as well as the charge Q .

To simplify things, we would prefer to have a field that depends only on Q and not on the test charge q . The electric field is defined in such a manner that it represents only the charge creating it and is unique at every point in space. Specifically, the electric field E is defined to be the ratio of the Coulomb force to the test charge:

$$\mathbf{E} = \frac{\mathbf{F}}{q}, \quad (18.11)$$

where \mathbf{F} is the electrostatic force (or Coulomb force) exerted on a positive test charge q . It is understood that \mathbf{E} is in the same direction as \mathbf{F} . It is also assumed that q is so small that it does not alter the charge distribution creating the electric field.

The units of electric field are newtons per coulomb (N/C). If the electric field is known, then the electrostatic force on any charge q is simply obtained by multiplying charge times electric field, or $\mathbf{F} = q\mathbf{E}$. Consider the electric field due to a point charge Q .

According to Coulomb's law, the force it exerts on a test charge q is $F = k|qQ|/r^2$. Thus the magnitude of the electric field, E , for a point charge is

$$E = \left| \frac{F}{q} \right| = k \left| \frac{qQ}{qr^2} \right| = k \frac{|Q|}{r^2}. \quad (18.12)$$

Since the test charge cancels, we see that

$$E = k \frac{|Q|}{r^2}. \quad (18.13)$$

The electric field is thus seen to depend only on the charge Q and the distance r ; it is completely independent of the test charge q .

Example 18.2 Calculating the Electric Field of a Point Charge

Calculate the strength and direction of the electric field E due to a point charge of 2.00 nC (nano-Coulombs) at a distance of 5.00 mm from the charge.

Strategy

We can find the electric field created by a point charge by using the equation $E = kQ/r^2$.

Solution

Here $Q = 2.00 \times 10^{-9}$ C and $r = 5.00 \times 10^{-3}$ m. Entering those values into the above equation gives

$$\begin{aligned} E &= k \frac{Q}{r^2} && (18.14) \\ &= (8.99 \times 10^9 \text{ N} \cdot \text{m}^2/\text{C}^2) \times \frac{(2.00 \times 10^{-9} \text{ C})}{(5.00 \times 10^{-3} \text{ m})^2} \\ &= 7.19 \times 10^5 \text{ N/C}. \end{aligned}$$

Discussion

This **electric field strength** is the same at any point 5.00 mm away from the charge Q that creates the field. It is positive, meaning that it has a direction pointing away from the charge Q .

Example 18.3 Calculating the Force Exerted on a Point Charge by an Electric Field

What force does the electric field found in the previous example exert on a point charge of $-0.250 \mu\text{C}$?

Strategy

Since we know the electric field strength and the charge in the field, the force on that charge can be calculated using the definition of electric field $\mathbf{E} = \mathbf{F}/q$ rearranged to $\mathbf{F} = q\mathbf{E}$.

Solution

The magnitude of the force on a charge $q = -0.250 \mu\text{C}$ exerted by a field of strength $E = 7.20 \times 10^5$ N/C is thus,

$$\begin{aligned} F &= -qE && (18.15) \\ &= (0.250 \times 10^{-6} \text{ C})(7.20 \times 10^5 \text{ N/C}) \\ &= 0.180 \text{ N}. \end{aligned}$$

Because q is negative, the force is directed opposite to the direction of the field.

Discussion

The force is attractive, as expected for unlike charges. (The field was created by a positive charge and here acts on a negative charge.) The charges in this example are typical of common static electricity, and the modest attractive force obtained is similar to forces experienced in static cling and similar situations.

PhET Explorations: Electric Field of Dreams

Play ball! Add charges to the Field of Dreams and see how they react to the electric field. Turn on a background electric field and adjust the direction and magnitude.



PhET Interactive Simulation

Figure 18.21 Electric Field of Dreams (http://cnx.org/content/m42310/1.6/efield_en.jar)

18.5 Electric Field Lines: Multiple Charges

Drawings using lines to represent **electric fields** around charged objects are very useful in visualizing field strength and direction. Since the electric field has both magnitude and direction, it is a vector. Like all **vectors**, the electric field can be represented by an arrow that has length proportional to its magnitude and that points in the correct direction. (We have used arrows extensively to represent force vectors, for example.)

Figure 18.22 shows two pictorial representations of the same electric field created by a positive point charge Q . **Figure 18.22** (b) shows the standard representation using continuous lines. **Figure 18.22** (b) shows numerous individual arrows with each arrow representing the force on a test charge q . Field lines are essentially a map of infinitesimal force vectors.

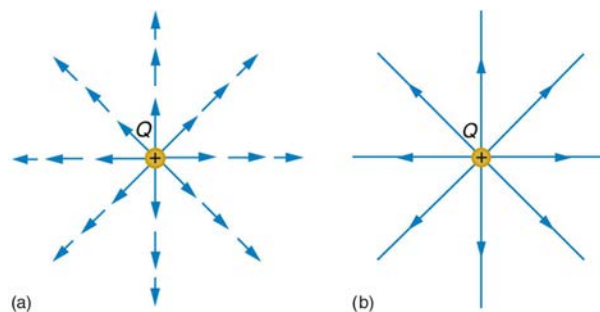

Figure 18.22 Two equivalent representations of the electric field due to a positive charge Q . (a) Arrows representing the electric field's magnitude and direction. (b) In the standard representation, the arrows are replaced by continuous field lines having the same direction at any point as the electric field. The closeness of the lines is directly related to the strength of the electric field. A test charge placed anywhere will feel a force in the direction of the field line; this force will have a strength proportional to the density of the lines (being greater near the charge, for example).

Note that the electric field is defined for a positive test charge q , so that the field lines point away from a positive charge and toward a negative charge. (See **Figure 18.23**.) The electric field strength is exactly proportional to the number of field lines per unit area, since the magnitude of the electric field for a point charge is $E = k|Q|/r^2$ and area is proportional to r^2 . This pictorial representation, in which field lines represent the direction and their closeness (that is, their areal density or the number of lines crossing a unit area) represents strength, is used for all fields: electrostatic, gravitational, magnetic, and others.

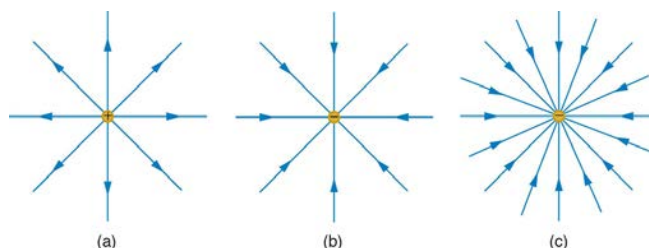

Figure 18.23 The electric field surrounding three different point charges. (a) A positive charge. (b) A negative charge of equal magnitude. (c) A larger negative charge.

In many situations, there are multiple charges. The total electric field created by multiple charges is the vector sum of the individual fields created by each charge. The following example shows how to add electric field vectors.

Example 18.4 Adding Electric Fields

Find the magnitude and direction of the total electric field due to the two point charges, q_1 and q_2 , at the origin of the coordinate system as shown in **Figure 18.24**.

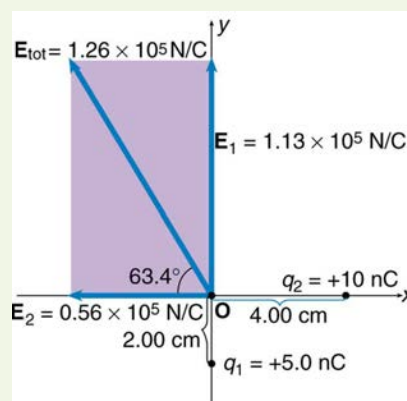

Figure 18.24 The electric fields \mathbf{E}_1 and \mathbf{E}_2 at the origin O add to \mathbf{E}_{tot} .

Strategy

Since the electric field is a vector (having magnitude and direction), we add electric fields with the same vector techniques used for other types of vectors. We first must find the electric field due to each charge at the point of interest, which is the origin of the coordinate system (O) in this instance. We pretend that there is a positive test charge, q , at point O, which allows us to determine the direction of the fields \mathbf{E}_1 and \mathbf{E}_2 . Once those fields are found, the total field can be determined using **vector addition**.

Solution

The electric field strength at the origin due to q_1 is labeled E_1 and is calculated:

$$E_1 = k \frac{q_1}{r_1^2} = (8.99 \times 10^9 \text{ N} \cdot \text{m}^2/\text{C}^2) \frac{(5.00 \times 10^{-9} \text{ C})}{(2.00 \times 10^{-2} \text{ m})^2} \quad (18.16)$$

$$E_1 = 1.124 \times 10^5 \text{ N/C}.$$

Similarly, E_2 is

$$E_2 = k \frac{q_2}{r_2^2} = (8.99 \times 10^9 \text{ N} \cdot \text{m}^2/\text{C}^2) \frac{(10.0 \times 10^{-9} \text{ C})}{(4.00 \times 10^{-2} \text{ m})^2} \quad (18.17)$$

$$E_2 = 0.5619 \times 10^5 \text{ N/C}.$$

Four digits have been retained in this solution to illustrate that E_1 is exactly twice the magnitude of E_2 . Now arrows are drawn to represent the magnitudes and directions of \mathbf{E}_1 and \mathbf{E}_2 . (See **Figure 18.24**.) The direction of the electric field is that of the force on a positive charge so both arrows point directly away from the positive charges that create them. The arrow for \mathbf{E}_1 is exactly twice the length of that for \mathbf{E}_2 . The arrows form a right triangle in this case and can be added using the Pythagorean theorem. The magnitude of the total field E_{tot} is

$$\begin{aligned} E_{\text{tot}} &= (E_1^2 + E_2^2)^{1/2} & (18.18) \\ &= \{(1.124 \times 10^5 \text{ N/C})^2 + (0.5619 \times 10^5 \text{ N/C})^2\}^{1/2} \\ &= 1.26 \times 10^5 \text{ N/C}. \end{aligned}$$

The direction is

$$\begin{aligned} \theta &= \tan^{-1} \left(\frac{E_1}{E_2} \right) & (18.19) \\ &= \tan^{-1} \left(\frac{1.124 \times 10^5 \text{ N/C}}{0.5619 \times 10^5 \text{ N/C}} \right) \\ &= 63.4^\circ, \end{aligned}$$

or 63.4° above the x -axis.

Discussion

In cases where the electric field vectors to be added are not perpendicular, vector components or graphical techniques can be used. The total electric field found in this example is the total electric field at only one point in space. To find the total electric field due to these two charges over an entire region, the same technique must be repeated for each point in the region. This impossibly lengthy task (there are an infinite number of points in space) can be avoided by calculating the total field at representative points and using some of the unifying features noted next.

Figure 18.25 shows how the electric field from two point charges can be drawn by finding the total field at representative points and drawing electric field lines consistent with those points. While the electric fields from multiple charges are more complex than those of single charges, some simple features are easily noticed.

For example, the field is weaker between like charges, as shown by the lines being farther apart in that region. (This is because the fields from each charge exert opposing forces on any charge placed between them.) (See **Figure 18.25** and **Figure 18.26(a)**.) Furthermore, at a great distance from two like charges, the field becomes identical to the field from a single, larger charge.

Figure 18.26(b) shows the electric field of two unlike charges. The field is stronger between the charges. In that region, the fields from each charge are in the same direction, and so their strengths add. The field of two unlike charges is weak at large distances, because the fields of the individual charges are in opposite directions and so their strengths subtract. At very large distances, the field of two unlike charges looks like that of a smaller single charge.

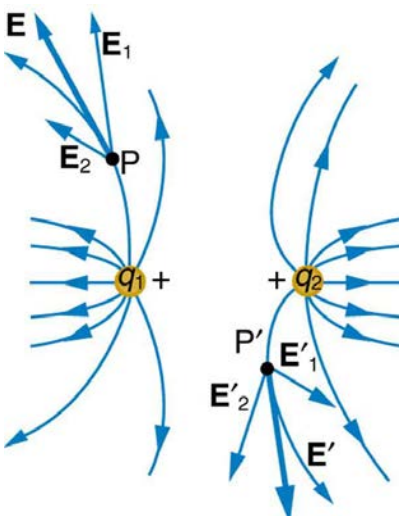

Figure 18.25 Two positive point charges q_1 and q_2 produce the resultant electric field shown. The field is calculated at representative points and then smooth field lines drawn following the rules outlined in the text.

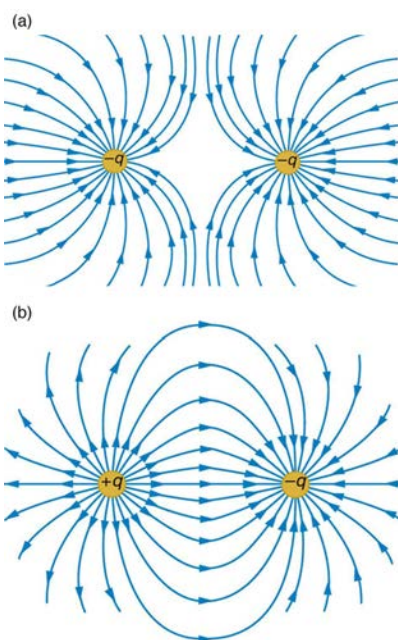

Figure 18.26 (a) Two negative charges produce the fields shown. It is very similar to the field produced by two positive charges, except that the directions are reversed. The field is clearly weaker between the charges. The individual forces on a test charge in that region are in opposite directions. (b) Two opposite charges produce the field shown, which is stronger in the region between the charges.

We use electric field lines to visualize and analyze electric fields (the lines are a pictorial tool, not a physical entity in themselves). The properties of electric field lines for any charge distribution can be summarized as follows:

1. Field lines must begin on positive charges and terminate on negative charges, or at infinity in the hypothetical case of isolated charges.
2. The number of field lines leaving a positive charge or entering a negative charge is proportional to the magnitude of the charge.
3. The strength of the field is proportional to the closeness of the field lines—more precisely, it is proportional to the number of lines per unit area perpendicular to the lines.
4. The direction of the electric field is tangent to the field line at any point in space.
5. Field lines can never cross.

The last property means that the field is unique at any point. The field line represents the direction of the field; so if they crossed, the field would have two directions at that location (an impossibility if the field is unique).

PhET Explorations: Charges and Fields

Move point charges around on the playing field and then view the electric field, voltages, equipotential lines, and more. It's colorful, it's dynamic, it's free.



PhET Interactive Simulation

Figure 18.27 Charges and Fields (http://cnx.org/content/m42312/1.7/charges-and-fields_en.jar)

18.6 Electric Forces in Biology

Classical electrostatics has an important role to play in modern molecular biology. Large molecules such as proteins, nucleic acids, and so on—so important to life—are usually electrically charged. DNA itself is highly charged; it is the electrostatic force that not only holds the molecule together but gives the molecule structure and strength. **Figure 18.28** is a schematic of the DNA double helix.

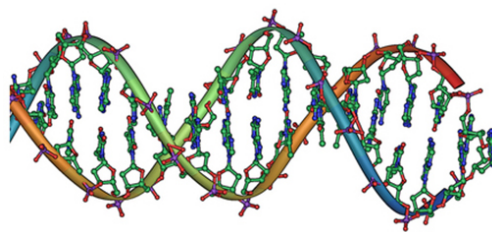

Figure 18.28 DNA is a highly charged molecule. The DNA double helix shows the two coiled strands each containing a row of nitrogenous bases, which “code” the genetic information needed by a living organism. The strands are connected by bonds between pairs of bases. While pairing combinations between certain bases are fixed (C-G and A-T), the sequence of nucleotides in the strand varies. (credit: Jerome Walker)

The four nucleotide bases are given the symbols A (adenine), C (cytosine), G (guanine), and T (thymine). The order of the four bases varies in each strand, but the pairing between bases is always the same. C and G are always paired and A and T are always paired, which helps to preserve the order of bases in cell division (mitosis) so as to pass on the correct genetic information. Since the Coulomb force drops with distance ($F \propto 1/r^2$), the distances between the base pairs must be small enough that the electrostatic force is sufficient to hold them together.

DNA is a highly charged molecule, with about $2q_e$ (fundamental charge) per 0.3×10^{-9} m. The distance separating the two strands that make up the DNA structure is about 1 nm, while the distance separating the individual atoms within each base is about 0.3 nm.

One might wonder why electrostatic forces do not play a larger role in biology than they do if we have so many charged molecules. The reason is that the electrostatic force is “diluted” due to **screening** between molecules. This is due to the presence of other charges in the cell.

Polarity of Water Molecules

The best example of this charge screening is the water molecule, represented as H_2O . Water is a strongly **polar molecule**. Its 10 electrons (8 from the oxygen atom and 2 from the two hydrogen atoms) tend to remain closer to the oxygen nucleus than the hydrogen nuclei. This creates two centers of equal and opposite charges—what is called a **dipole**, as illustrated in **Figure 18.29**. The magnitude of the dipole is called the dipole moment.

These two centers of charge will terminate some of the electric field lines coming from a free charge, as on a DNA molecule. This results in a reduction in the strength of the **Coulomb interaction**. One might say that screening makes the Coulomb force a short range force rather than long range.

Other ions of importance in biology that can reduce or screen Coulomb interactions are Na^+ , and K^+ , and Cl^- . These ions are located both inside and outside of living cells. The movement of these ions through cell membranes is crucial to the motion of nerve impulses through nerve axons.

Recent studies of electrostatics in biology seem to show that electric fields in cells can be extended over larger distances, in spite of screening, by “microtubules” within the cell. These microtubules are hollow tubes composed of proteins that guide the movement of chromosomes when cells divide, the motion of other organisms within the cell, and provide mechanisms for motion of some cells (as motors).

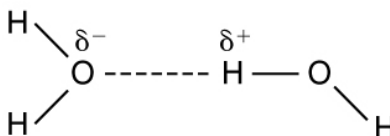

Figure 18.29 This schematic shows water (H_2O) as a polar molecule. Unequal sharing of electrons between the oxygen (O) and hydrogen (H) atoms leads to a net separation of positive and negative charge—forming a dipole. The symbols δ^- and δ^+ indicate that the oxygen side of the H_2O molecule tends to be more negative, while the hydrogen ends tend to be more positive. This leads to an attraction of opposite charges between molecules.

18.7 Conductors and Electric Fields in Static Equilibrium

Conductors contain **free charges** that move easily. When excess charge is placed on a conductor or the conductor is put into a static electric field, charges in the conductor quickly respond to reach a steady state called **electrostatic equilibrium**.

Figure 18.30 shows the effect of an electric field on free charges in a conductor. The free charges move until the field is perpendicular to the conductor’s surface. There can be no component of the field parallel to the surface in electrostatic equilibrium, since, if there were, it would produce further movement of charge. A positive free charge is shown, but free charges can be either positive or negative and are, in fact, negative in metals. The motion of a positive charge is equivalent to the motion of a negative charge in the opposite direction.

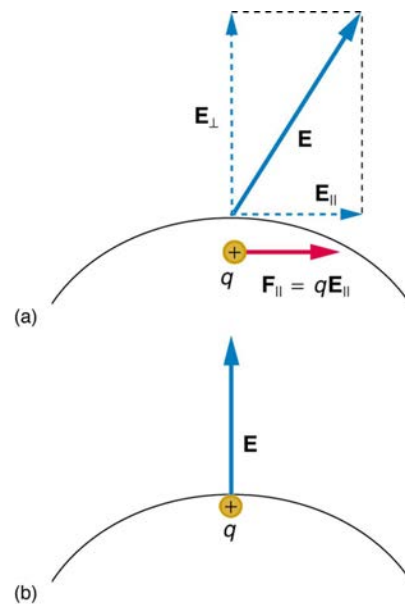

Figure 18.30 When an electric field \mathbf{E} is applied to a conductor, free charges inside the conductor move until the field is perpendicular to the surface. (a) The electric field is a vector quantity, with both parallel and perpendicular components. The parallel component (\mathbf{E}_{\parallel}) exerts a force (\mathbf{F}_{\parallel}) on the free charge q , which moves the charge until $\mathbf{F}_{\parallel} = 0$. (b) The resulting field is perpendicular to the surface. The free charge has been brought to the conductor's surface, leaving electrostatic forces in equilibrium.

A conductor placed in an **electric field** will be **polarized**. **Figure 18.31** shows the result of placing a neutral conductor in an originally uniform electric field. The field becomes stronger near the conductor but entirely disappears inside it.

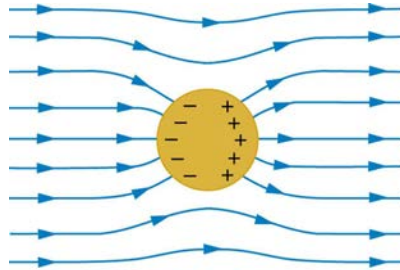

Figure 18.31 This illustration shows a spherical conductor in static equilibrium with an originally uniform electric field. Free charges move within the conductor, polarizing it, until the electric field lines are perpendicular to the surface. The field lines end on excess negative charge on one section of the surface and begin again on excess positive charge on the opposite side. No electric field exists inside the conductor, since free charges in the conductor would continue moving in response to any field until it was neutralized.

Misconception Alert: Electric Field inside a Conductor

Excess charges placed on a spherical conductor repel and move until they are evenly distributed, as shown in **Figure 18.32**. Excess charge is forced to the surface until the field inside the conductor is zero. Outside the conductor, the field is exactly the same as if the conductor were replaced by a point charge at its center equal to the excess charge.

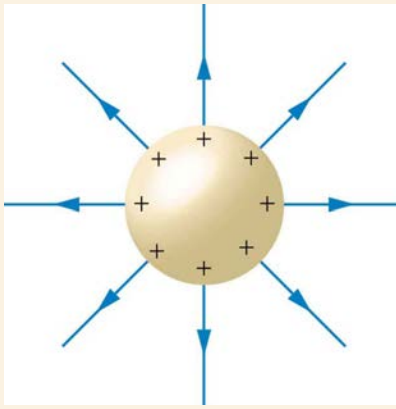

Figure 18.32 The mutual repulsion of excess positive charges on a spherical conductor distributes them uniformly on its surface. The resulting electric field is perpendicular to the surface and zero inside. Outside the conductor, the field is identical to that of a point charge at the center equal to the excess charge.

Properties of a Conductor in Electrostatic Equilibrium

1. The electric field is zero inside a conductor.
2. Just outside a conductor, the electric field lines are perpendicular to its surface, ending or beginning on charges on the surface.
3. Any excess charge resides entirely on the surface or surfaces of a conductor.

The properties of a conductor are consistent with the situations already discussed and can be used to analyze any conductor in electrostatic equilibrium. This can lead to some interesting new insights, such as described below.

How can a very uniform electric field be created? Consider a system of two metal plates with opposite charges on them, as shown in **Figure 18.33**. The properties of conductors in electrostatic equilibrium indicate that the electric field between the plates will be uniform in strength and direction. Except near the edges, the excess charges distribute themselves uniformly, producing field lines that are uniformly spaced (hence uniform in strength) and perpendicular to the surfaces (hence uniform in direction, since the plates are flat). The edge effects are less important when the plates are close together.

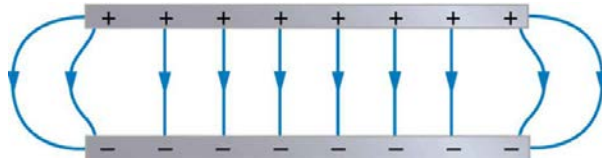

Figure 18.33 Two metal plates with equal, but opposite, excess charges. The field between them is uniform in strength and direction except near the edges. One use of such a field is to produce uniform acceleration of charges between the plates, such as in the electron gun of a TV tube.

Earth's Electric Field

A near uniform electric field of approximately 150 N/C, directed downward, surrounds Earth, with the magnitude increasing slightly as we get closer to the surface. What causes the electric field? At around 100 km above the surface of Earth we have a layer of charged particles, called the **ionosphere**. The ionosphere is responsible for a range of phenomena including the electric field surrounding Earth. In fair weather the ionosphere is positive and the Earth largely negative, maintaining the electric field (**Figure 18.34(a)**).

In storm conditions clouds form and localized electric fields can be larger and reversed in direction (**Figure 18.34(b)**). The exact charge distributions depend on the local conditions, and variations of **Figure 18.34(b)** are possible.

If the electric field is sufficiently large, the insulating properties of the surrounding material break down and it becomes conducting. For air this occurs at around 3×10^6 N/C. Air ionizes ions and electrons recombine, and we get discharge in the form of lightning sparks and corona discharge.

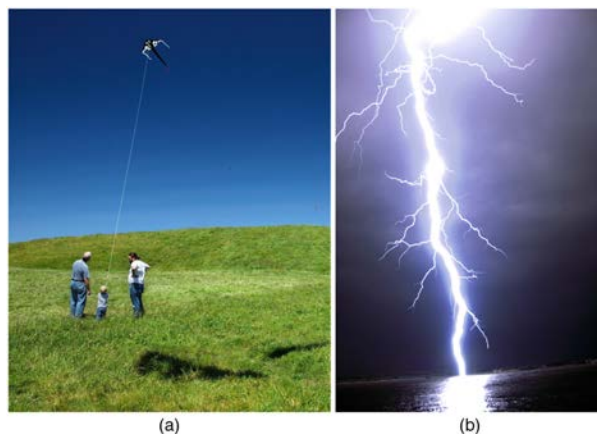

Figure 18.34 Earth's electric field. (a) Fair weather field. Earth and the ionosphere (a layer of charged particles) are both conductors. They produce a uniform electric field of about 150 N/C. (credit: D. H. Parks) (b) Storm fields. In the presence of storm clouds, the local electric fields can be larger. At very high fields, the insulating properties of the air break down and lightning can occur. (credit: Jan-Joost Verhoef)

Electric Fields on Uneven Surfaces

So far we have considered excess charges on a smooth, symmetrical conductor surface. What happens if a conductor has sharp corners or is pointed? Excess charges on a nonuniform conductor become concentrated at the sharpest points. Additionally, excess charge may move on or off the conductor at the sharpest points.

To see how and why this happens, consider the charged conductor in **Figure 18.35**. The electrostatic repulsion of like charges is most effective in moving them apart on the flattest surface, and so they become least concentrated there. This is because the forces between identical pairs of charges at either end of the conductor are identical, but the components of the forces parallel to the surfaces are different. The component parallel to the surface is greatest on the flattest surface and, hence, more effective in moving the charge.

The same effect is produced on a conductor by an externally applied electric field, as seen in **Figure 18.35** (c). Since the field lines must be perpendicular to the surface, more of them are concentrated on the most curved parts.

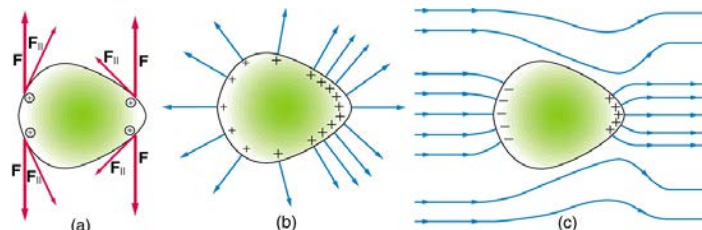

Figure 18.35 Excess charge on a nonuniform conductor becomes most concentrated at the location of greatest curvature. (a) The forces between identical pairs of charges at either end of the conductor are identical, but the components of the forces parallel to the surface are different. It is \mathbf{F}_{\parallel} that moves the charges apart once they have reached the surface. (b) \mathbf{F}_{\parallel} is smallest at the more pointed end, the charges are left closer together, producing the electric field shown. (c) An uncharged conductor in an originally uniform electric field is polarized, with the most concentrated charge at its most pointed end.

Applications of Conductors

On a very sharply curved surface, such as shown in **Figure 18.36**, the charges are so concentrated at the point that the resulting electric field can be great enough to remove them from the surface. This can be useful.

Lightning rods work best when they are most pointed. The large charges created in storm clouds induce an opposite charge on a building that can result in a lightning bolt hitting the building. The induced charge is bled away continually by a lightning rod, preventing the more dramatic lightning strike.

Of course, we sometimes wish to prevent the transfer of charge rather than to facilitate it. In that case, the conductor should be very smooth and have as large a radius of curvature as possible. (See **Figure 18.37**.) Smooth surfaces are used on high-voltage transmission lines, for example, to avoid leakage of charge into the air.

Another device that makes use of some of these principles is a **Faraday cage**. This is a metal shield that encloses a volume. All electrical charges will reside on the outside surface of this shield, and there will be no electrical field inside. A Faraday cage is used to prohibit stray electrical fields in the environment from interfering with sensitive measurements, such as the electrical signals inside a nerve cell.

During electrical storms if you are driving a car, it is best to stay inside the car as its metal body acts as a Faraday cage with zero electrical field inside. If in the vicinity of a lightning strike, its effect is felt on the outside of the car and the inside is unaffected, provided you remain totally inside. This is also true if an active (“hot”) electrical wire was broken (in a storm or an accident) and fell on your car.

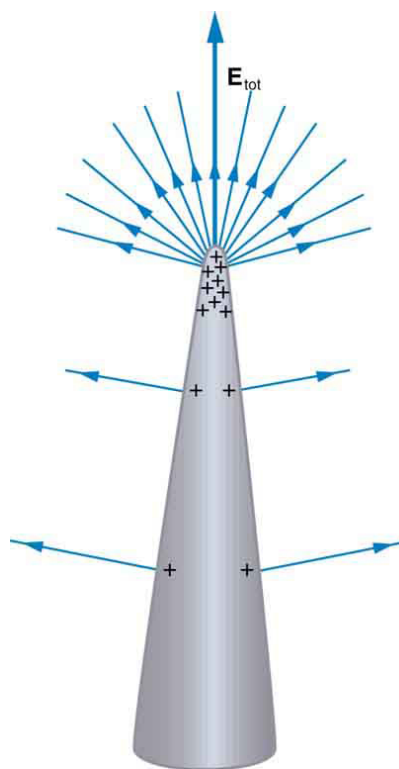

Figure 18.36 A very pointed conductor has a large charge concentration at the point. The electric field is very strong at the point and can exert a force large enough to transfer charge on or off the conductor. Lightning rods are used to prevent the buildup of large excess charges on structures and, thus, are pointed.



Figure 18.37 (a) A lightning rod is pointed to facilitate the transfer of charge. (credit: Romaine, Wikimedia Commons) (b) This Van de Graaff generator has a smooth surface with a large radius of curvature to prevent the transfer of charge and allow a large voltage to be generated. The mutual repulsion of like charges is evident in the person's hair while touching the metal sphere. (credit: Jon 'ShakataGaNai' Davis/Wikimedia Commons).

18.8 Applications of Electrostatics

The study of **electrostatics** has proven useful in many areas. This module covers just a few of the many applications of electrostatics.

The Van de Graaff Generator

Van de Graaff generators (or Van de Graaffs) are not only spectacular devices used to demonstrate high voltage due to static electricity—they are also used for serious research. The first was built by Robert Van de Graaff in 1931 (based on original suggestions by Lord Kelvin) for use in nuclear physics research. **Figure 18.38** shows a schematic of a large research version. Van de Graaffs utilize both smooth and pointed surfaces, and conductors and insulators to generate large static charges and, hence, large voltages.

A very large excess charge can be deposited on the sphere, because it moves quickly to the outer surface. Practical limits arise because the large electric fields polarize and eventually ionize surrounding materials, creating free charges that neutralize excess charge or allow it to escape. Nevertheless, voltages of 15 million volts are well within practical limits.

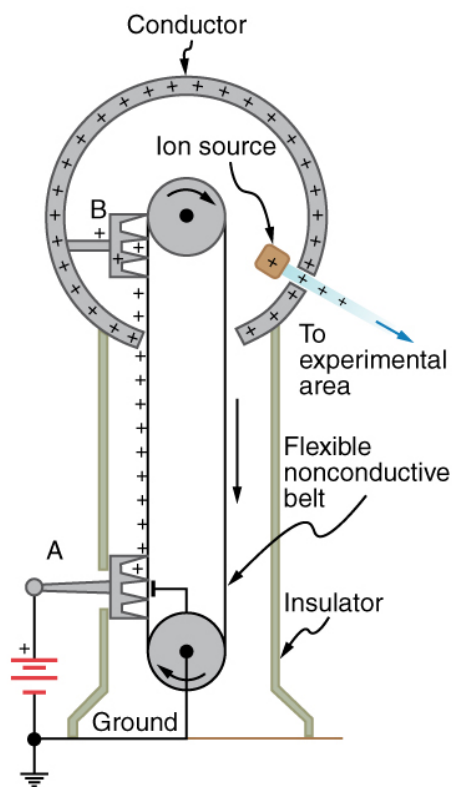

Figure 18.38 Schematic of Van de Graaff generator. A battery (A) supplies excess positive charge to a pointed conductor, the points of which spray the charge onto a moving insulating belt near the bottom. The pointed conductor (B) on top in the large sphere picks up the charge. (The induced electric field at the points is so large that it removes the charge from the belt.) This can be done because the charge does not remain inside the conducting sphere but moves to its outside surface. An ion source inside the sphere produces positive ions, which are accelerated away from the positive sphere to high velocities.

Take-Home Experiment: Electrostatics and Humidity

Rub a comb through your hair and use it to lift pieces of paper. It may help to tear the pieces of paper rather than cut them neatly. Repeat the exercise in your bathroom after you have had a long shower and the air in the bathroom is moist. Is it easier to get electrostatic effects in dry or moist air? Why would torn paper be more attractive to the comb than cut paper? Explain your observations.

Xerography

Most copy machines use an electrostatic process called **xerography**—a word coined from the Greek words *xeros* for dry and *graphos* for writing. The heart of the process is shown in simplified form in **Figure 18.39**.

A selenium-coated aluminum drum is sprayed with positive charge from points on a device called a corotron. Selenium is a substance with an interesting property—it is a **photoconductor**. That is, selenium is an insulator when in the dark and a conductor when exposed to light.

In the first stage of the xerography process, the conducting aluminum drum is **grounded** so that a negative charge is induced under the thin layer of uniformly positively charged selenium. In the second stage, the surface of the drum is exposed to the image of whatever is to be copied. Where the image is light, the selenium becomes conducting, and the positive charge is neutralized. In dark areas, the positive charge remains, and so the image has been transferred to the drum.

The third stage takes a dry black powder, called toner, and sprays it with a negative charge so that it will be attracted to the positive regions of the drum. Next, a blank piece of paper is given a greater positive charge than on the drum so that it will pull the toner from the drum. Finally, the paper and electrostatically held toner are passed through heated pressure rollers, which melt and permanently adhere the toner within the fibers of the paper.

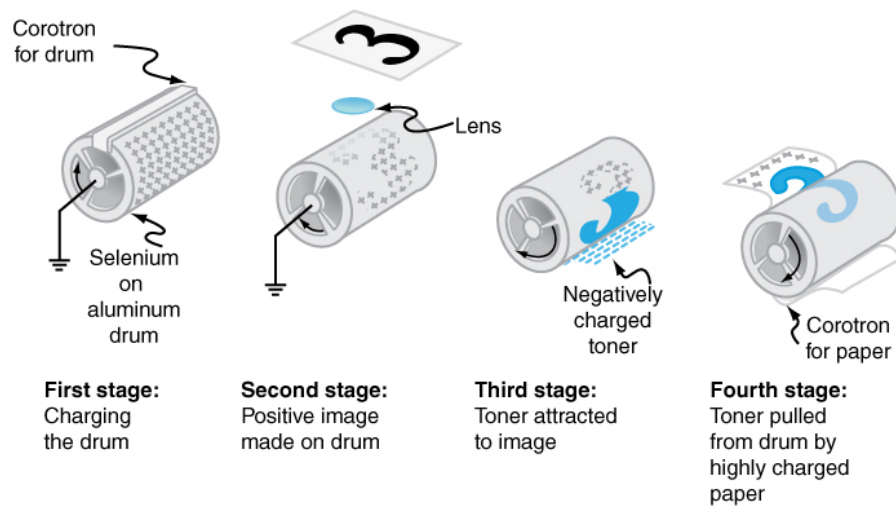

Figure 18.39 Xerography is a dry copying process based on electrostatics. The major steps in the process are the charging of the photoconducting drum, transfer of an image creating a positive charge duplicate, attraction of toner to the charged parts of the drum, and transfer of toner to the paper. Not shown are heat treatment of the paper and cleansing of the drum for the next copy.

Laser Printers

Laser printers use the xerographic process to make high-quality images on paper, employing a laser to produce an image on the photoconducting drum as shown in **Figure 18.40**. In its most common application, the laser printer receives output from a computer, and it can achieve high-quality output because of the precision with which laser light can be controlled. Many laser printers do significant information processing, such as making sophisticated letters or fonts, and may contain a computer more powerful than the one giving them the raw data to be printed.

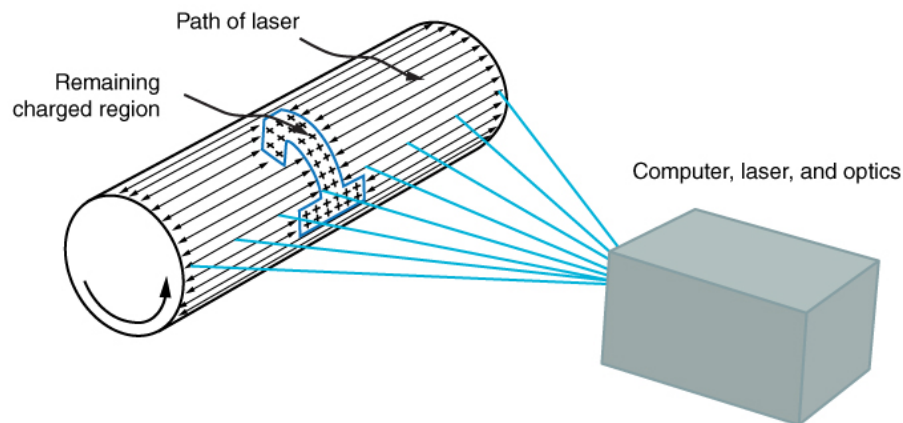

Figure 18.40 In a laser printer, a laser beam is scanned across a photoconducting drum, leaving a positive charge image. The other steps for charging the drum and transferring the image to paper are the same as in xerography. Laser light can be very precisely controlled, enabling laser printers to produce high-quality images.

Ink Jet Printers and Electrostatic Painting

The **ink jet printer**, commonly used to print computer-generated text and graphics, also employs electrostatics. A nozzle makes a fine spray of tiny ink droplets, which are then given an electrostatic charge. (See **Figure 18.41**.)

Once charged, the droplets can be directed, using pairs of charged plates, with great precision to form letters and images on paper. Ink jet printers can produce color images by using a black jet and three other jets with primary colors, usually cyan, magenta, and yellow, much as a color television produces color. (This is more difficult with xerography, requiring multiple drums and toners.)

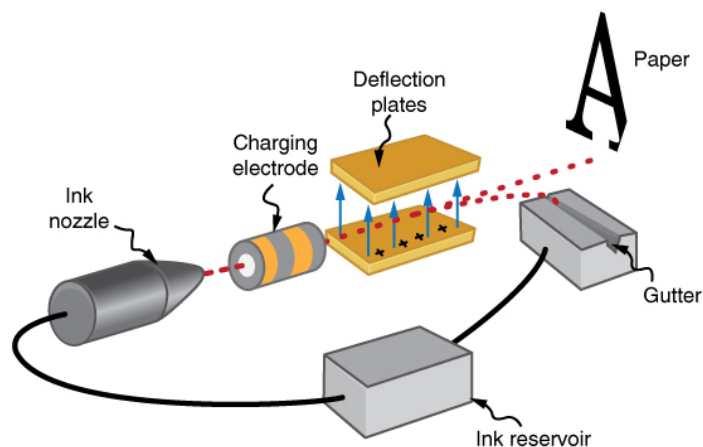

Figure 18.41 The nozzle of an ink-jet printer produces small ink droplets, which are sprayed with electrostatic charge. Various computer-driven devices are then used to direct the droplets to the correct positions on a page.

Electrostatic painting employs electrostatic charge to spray paint onto odd-shaped surfaces. Mutual repulsion of like charges causes the paint to fly away from its source. Surface tension forms drops, which are then attracted by unlike charges to the surface to be painted. Electrostatic painting can reach those hard-to-get-at places, applying an even coat in a controlled manner. If the object is a conductor, the electric field is perpendicular to the surface, tending to bring the drops in perpendicularly. Corners and points on conductors will receive extra paint. Felt can similarly be applied.

Smoke Precipitators and Electrostatic Air Cleaning

Another important application of electrostatics is found in air cleaners, both large and small. The electrostatic part of the process places excess (usually positive) charge on smoke, dust, pollen, and other particles in the air and then passes the air through an oppositely charged grid that attracts and retains the charged particles. (See **Figure 18.42**.)

Large **electrostatic precipitators** are used industrially to remove over 99% of the particles from stack gas emissions associated with the burning of coal and oil. Home precipitators, often in conjunction with the home heating and air conditioning system, are very effective in removing polluting particles, irritants, and allergens.

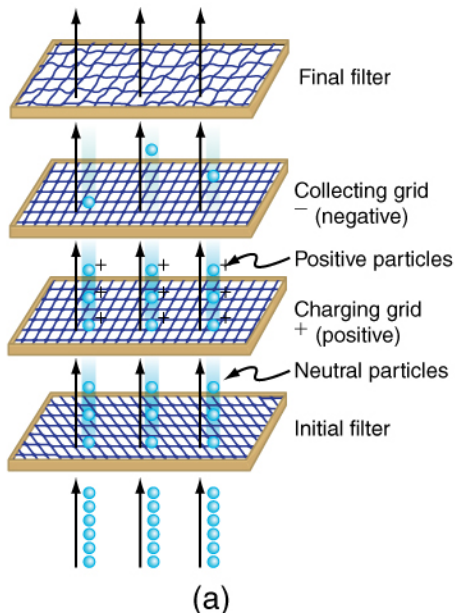

Figure 18.42 (a) Schematic of an electrostatic precipitator. Air is passed through grids of opposite charge. The first grid charges airborne particles, while the second attracts and collects them. (b) The dramatic effect of electrostatic precipitators is seen by the absence of smoke from this power plant. (credit: Cmdalgleish, Wikimedia Commons)

Problem-Solving Strategies for Electrostatics

1. Examine the situation to determine if static electricity is involved. This may concern separated stationary charges, the forces among them, and the electric fields they create.
2. Identify the system of interest. This includes noting the number, locations, and types of charges involved.

- Identify exactly what needs to be determined in the problem (identify the unknowns). A written list is useful. Determine whether the Coulomb force is to be considered directly—if so, it may be useful to draw a free-body diagram, using electric field lines.
- Make a list of what is given or can be inferred from the problem as stated (identify the knowns). It is important to distinguish the Coulomb force F from the electric field E , for example.
- Solve the appropriate equation for the quantity to be determined (the unknown) or draw the field lines as requested.
- Examine the answer to see if it is reasonable: Does it make sense? Are units correct and the numbers involved reasonable?

Integrated Concepts

The Integrated Concepts exercises for this module involve concepts such as electric charges, electric fields, and several other topics. Physics is most interesting when applied to general situations involving more than a narrow set of physical principles. The electric field exerts force on charges, for example, and hence the relevance of **Dynamics: Force and Newton's Laws of Motion**. The following topics are involved in some or all of the problems labeled "Integrated Concepts":

- Kinematics
- Two-Dimensional Kinematics
- Dynamics: Force and Newton's Laws of Motion
- Uniform Circular Motion and Gravitation
- Statics and Torque
- Fluid Statics

The following worked example illustrates how this strategy is applied to an Integrated Concept problem:

Example 18.5 Acceleration of a Charged Drop of Gasoline

If steps are not taken to ground a gasoline pump, static electricity can be placed on gasoline when filling your car's tank. Suppose a tiny drop of gasoline has a mass of 4.00×10^{-15} kg and is given a positive charge of 3.20×10^{-19} C. (a) Find the weight of the drop. (b) Calculate the electric force on the drop if there is an upward electric field of strength 3.00×10^5 N/C due to other static electricity in the vicinity. (c) Calculate the drop's acceleration.

Strategy

To solve an integrated concept problem, we must first identify the physical principles involved and identify the chapters in which they are found. Part (a) of this example asks for weight. This is a topic of dynamics and is defined in **Dynamics: Force and Newton's Laws of Motion**. Part (b) deals with electric force on a charge, a topic of **Electric Charge and Electric Field**. Part (c) asks for acceleration, knowing forces and mass. These are part of Newton's laws, also found in **Dynamics: Force and Newton's Laws of Motion**.

The following solutions to each part of the example illustrate how the specific problem-solving strategies are applied. These involve identifying knowns and unknowns, checking to see if the answer is reasonable, and so on.

Solution for (a)

Weight is mass times the acceleration due to gravity, as first expressed in

$$w = mg. \quad (18.20)$$

Entering the given mass and the average acceleration due to gravity yields

$$w = (4.00 \times 10^{-15} \text{ kg})(9.80 \text{ m/s}^2) = 3.92 \times 10^{-14} \text{ N}. \quad (18.21)$$

Discussion for (a)

This is a small weight, consistent with the small mass of the drop.

Solution for (b)

The force an electric field exerts on a charge is given by rearranging the following equation:

$$F = qE. \quad (18.22)$$

Here we are given the charge (3.20×10^{-19} C is twice the fundamental unit of charge) and the electric field strength, and so the electric force is found to be

$$F = (3.20 \times 10^{-19} \text{ C})(3.00 \times 10^5 \text{ N/C}) = 9.60 \times 10^{-14} \text{ N}. \quad (18.23)$$

Discussion for (b)

While this is a small force, it is greater than the weight of the drop.

Solution for (c)

The acceleration can be found using Newton's second law, provided we can identify all of the external forces acting on the drop. We assume only the drop's weight and the electric force are significant. Since the drop has a positive charge and the electric field is given to be upward, the electric force is upward. We thus have a one-dimensional (vertical direction) problem, and we can state Newton's second law as

$$a = \frac{F_{\text{net}}}{m}. \quad (18.24)$$

where $F_{\text{net}} = F - w$. Entering this and the known values into the expression for Newton's second law yields

$$\begin{aligned} a &= \frac{F - w}{m} & (18.25) \\ &= \frac{9.60 \times 10^{-14} \text{ N} - 3.92 \times 10^{-14} \text{ N}}{4.00 \times 10^{-15} \text{ kg}} \\ &= 14.2 \text{ m/s}^2. \end{aligned}$$

Discussion for (c)

This is an upward acceleration great enough to carry the drop to places where you might not wish to have gasoline.

This worked example illustrates how to apply problem-solving strategies to situations that include topics in different chapters. The first step is to identify the physical principles involved in the problem. The second step is to solve for the unknown using familiar problem-solving strategies. These are found throughout the text, and many worked examples show how to use them for single topics. In this integrated concepts example, you can see how to apply them across several topics. You will find these techniques useful in applications of physics outside a physics course, such as in your profession, in other science disciplines, and in everyday life. The following problems will build your skills in the broad application of physical principles.

Unreasonable Results

The Unreasonable Results exercises for this module have results that are unreasonable because some premise is unreasonable or because certain of the premises are inconsistent with one another. Physical principles applied correctly then produce unreasonable results. The purpose of these problems is to give practice in assessing whether nature is being accurately described, and if it is not to trace the source of difficulty.

Problem-Solving Strategy

To determine if an answer is reasonable, and to determine the cause if it is not, do the following.

1. Solve the problem using strategies as outlined above. Use the format followed in the worked examples in the text to solve the problem as usual.
2. Check to see if the answer is reasonable. Is it too large or too small, or does it have the wrong sign, improper units, and so on?
3. If the answer is unreasonable, look for what specifically could cause the identified difficulty. Usually, the manner in which the answer is unreasonable is an indication of the difficulty. For example, an extremely large Coulomb force could be due to the assumption of an excessively large separated charge.

Glossary

conductor: a material that allows electrons to move separately from their atomic orbits

conductor: an object with properties that allow charges to move about freely within it

Coulomb force: another term for the electrostatic force

Coulomb interaction: the interaction between two charged particles generated by the Coulomb forces they exert on one another

Coulomb's law: the mathematical equation calculating the electrostatic force vector between two charged particles

dipole: a molecule's lack of symmetrical charge distribution, causing one side to be more positive and another to be more negative

electric charge: a physical property of an object that causes it to be attracted toward or repelled from another charged object; each charged object generates and is influenced by a force called an electromagnetic force

electric field: a three-dimensional map of the electric force extended out into space from a point charge

- electric field lines:** a series of lines drawn from a point charge representing the magnitude and direction of force exerted by that charge
- electromagnetic force:** one of the four fundamental forces of nature; the electromagnetic force consists of static electricity, moving electricity and magnetism
- electron:** a particle orbiting the nucleus of an atom and carrying the smallest unit of negative charge
- electrostatic equilibrium:** an electrostatically balanced state in which all free electrical charges have stopped moving about
- electrostatic force:** the amount and direction of attraction or repulsion between two charged bodies
- electrostatic precipitators:** filters that apply charges to particles in the air, then attract those charges to a filter, removing them from the airstream
- electrostatic repulsion:** the phenomenon of two objects with like charges repelling each other
- electrostatics:** the study of electric forces that are static or slow-moving
- Faraday cage:** a metal shield which prevents electric charge from penetrating its surface
- field:** a map of the amount and direction of a force acting on other objects, extending out into space
- free charge:** an electrical charge (either positive or negative) which can move about separately from its base molecule
- free electron:** an electron that is free to move away from its atomic orbit
- grounded:** when a conductor is connected to the Earth, allowing charge to freely flow to and from Earth's unlimited reservoir
- grounded:** connected to the ground with a conductor, so that charge flows freely to and from the Earth to the grounded object
- induction:** the process by which an electrically charged object brought near a neutral object creates a charge in that object
- ink-jet printer:** small ink droplets sprayed with an electric charge are controlled by electrostatic plates to create images on paper
- insulator:** a material that holds electrons securely within their atomic orbits
- ionosphere:** a layer of charged particles located around 100 km above the surface of Earth, which is responsible for a range of phenomena including the electric field surrounding Earth
- laser printer:** uses a laser to create a photoconductive image on a drum, which attracts dry ink particles that are then rolled onto a sheet of paper to print a high-quality copy of the image
- law of conservation of charge:** states that whenever a charge is created, an equal amount of charge with the opposite sign is created simultaneously
- photoconductor:** a substance that is an insulator until it is exposed to light, when it becomes a conductor
- point charge:** A charged particle, designated Q , generating an electric field
- polar molecule:** a molecule with an asymmetrical distribution of positive and negative charge
- polarization:** slight shifting of positive and negative charges to opposite sides of an atom or molecule
- polarized:** a state in which the positive and negative charges within an object have collected in separate locations
- proton:** a particle in the nucleus of an atom and carrying a positive charge equal in magnitude and opposite in sign to the amount of negative charge carried by an electron
- screening:** the dilution or blocking of an electrostatic force on a charged object by the presence of other charges nearby
- static electricity:** a buildup of electric charge on the surface of an object
- test charge:** A particle (designated q) with either a positive or negative charge set down within an electric field generated by a point charge
- Van de Graaff generator:** a machine that produces a large amount of excess charge, used for experiments with high voltage
- vector:** a quantity with both magnitude and direction
- vector addition:** mathematical combination of two or more vectors, including their magnitudes, directions, and positions

xerography: a dry copying process based on electrostatics

Section Summary

18.1 Static Electricity and Charge: Conservation of Charge

- There are only two types of charge, which we call positive and negative.
- Like charges repel, unlike charges attract, and the force between charges decreases with the square of the distance.
- The vast majority of positive charge in nature is carried by protons, while the vast majority of negative charge is carried by electrons.
- The electric charge of one electron is equal in magnitude and opposite in sign to the charge of one proton.
- An ion is an atom or molecule that has nonzero total charge due to having unequal numbers of electrons and protons.
- The SI unit for charge is the coulomb (C), with protons and electrons having charges of opposite sign but equal magnitude; the magnitude of this basic charge $|q_e|$ is

$$|q_e| = 1.60 \times 10^{-19} \text{ C.}$$

- Whenever charge is created or destroyed, equal amounts of positive and negative are involved.
- Most often, existing charges are separated from neutral objects to obtain some net charge.
- Both positive and negative charges exist in neutral objects and can be separated by rubbing one object with another. For macroscopic objects, negatively charged means an excess of electrons and positively charged means a depletion of electrons.
- The law of conservation of charge ensures that whenever a charge is created, an equal charge of the opposite sign is created at the same time.

18.2 Conductors and Insulators

- Polarization is the separation of positive and negative charges in a neutral object.
- A conductor is a substance that allows charge to flow freely through its atomic structure.
- An insulator holds charge within its atomic structure.
- Objects with like charges repel each other, while those with unlike charges attract each other.
- A conducting object is said to be grounded if it is connected to the Earth through a conductor. Grounding allows transfer of charge to and from the earth's large reservoir.
- Objects can be charged by contact with another charged object and obtain the same sign charge.
- If an object is temporarily grounded, it can be charged by induction, and obtains the opposite sign charge.
- Polarized objects have their positive and negative charges concentrated in different areas, giving them a non-symmetrical charge.
- Polar molecules have an inherent separation of charge.

18.3 Coulomb's Law

- Frenchman Charles Coulomb was the first to publish the mathematical equation that describes the electrostatic force between two objects.
- Coulomb's law gives the magnitude of the force between point charges. It is

$$F = k \frac{|q_1 q_2|}{r^2},$$

where q_1 and q_2 are two point charges separated by a distance r , and $k \approx 8.99 \times 10^9 \text{ N} \cdot \text{m}^2 / \text{C}^2$

- This Coulomb force is extremely basic, since most charges are due to point-like particles. It is responsible for all electrostatic effects and underlies most macroscopic forces.
- The Coulomb force is extraordinarily strong compared with the gravitational force, another basic force—but unlike gravitational force it can cancel, since it can be either attractive or repulsive.
- The electrostatic force between two subatomic particles is far greater than the gravitational force between the same two particles.

18.4 Electric Field: Concept of a Field Revisited

- The electrostatic force field surrounding a charged object extends out into space in all directions.
- The electrostatic force exerted by a point charge on a test charge at a distance r depends on the charge of both charges, as well as the distance between the two.
- The electric field \mathbf{E} is defined to be

$$\mathbf{E} = \frac{\mathbf{F}}{q},$$

where \mathbf{F} is the Coulomb or electrostatic force exerted on a small positive test charge q . \mathbf{E} has units of N/C.

- The magnitude of the electric field \mathbf{E} created by a point charge Q is

$$\mathbf{E} = k \frac{|Q|}{r^2}$$

where r is the distance from Q . The electric field \mathbf{E} is a vector and fields due to multiple charges add like vectors.

18.5 Electric Field Lines: Multiple Charges

- Drawings of electric field lines are useful visual tools. The properties of electric field lines for any charge distribution are that:
- Field lines must begin on positive charges and terminate on negative charges, or at infinity in the hypothetical case of isolated charges.
- The number of field lines leaving a positive charge or entering a negative charge is proportional to the magnitude of the charge.
- The strength of the field is proportional to the closeness of the field lines—more precisely, it is proportional to the number of lines per unit area perpendicular to the lines.
- The direction of the electric field is tangent to the field line at any point in space.
- Field lines can never cross.

18.6 Electric Forces in Biology

- Many molecules in living organisms, such as DNA, carry a charge.
- An uneven distribution of the positive and negative charges within a polar molecule produces a dipole.
- The effect of a Coulomb field generated by a charged object may be reduced or blocked by other nearby charged objects.
- Biological systems contain water, and because water molecules are polar, they have a strong effect on other molecules in living systems.

18.7 Conductors and Electric Fields in Static Equilibrium

- A conductor allows free charges to move about within it.
- The electrical forces around a conductor will cause free charges to move around inside the conductor until static equilibrium is reached.
- Any excess charge will collect along the surface of a conductor.
- Conductors with sharp corners or points will collect more charge at those points.
- A lightning rod is a conductor with sharply pointed ends that collect excess charge on the building caused by an electrical storm and allow it to dissipate back into the air.
- Electrical storms result when the electrical field of Earth's surface in certain locations becomes more strongly charged, due to changes in the insulating effect of the air.
- A Faraday cage acts like a shield around an object, preventing electric charge from penetrating inside.

18.8 Applications of Electrostatics

- Electrostatics is the study of electric fields in static equilibrium.
- In addition to research using equipment such as a Van de Graaff generator, many practical applications of electrostatics exist, including photocopiers, laser printers, ink-jet printers and electrostatic air filters.

Conceptual Questions

18.1 Static Electricity and Charge: Conservation of Charge

1. There are very large numbers of charged particles in most objects. Why, then, don't most objects exhibit static electricity?
2. Why do most objects tend to contain nearly equal numbers of positive and negative charges?

18.2 Conductors and Insulators

3. An eccentric inventor attempts to levitate by first placing a large negative charge on himself and then putting a large positive charge on the ceiling of his workshop. Instead, while attempting to place a large negative charge on himself, his clothes fly off. Explain.
4. If you have charged an electroscope by contact with a positively charged object, describe how you could use it to determine the charge of other objects. Specifically, what would the leaves of the electroscope do if other charged objects were brought near its knob?
5. When a glass rod is rubbed with silk, it becomes positive and the silk becomes negative—yet both attract dust. Does the dust have a third type of charge that is attracted to both positive and negative? Explain.
6. Why does a car always attract dust right after it is polished? (Note that car wax and car tires are insulators.)
7. Describe how a positively charged object can be used to give another object a negative charge. What is the name of this process?
8. What is grounding? What effect does it have on a charged conductor? On a charged insulator?

18.3 Coulomb's Law

9. **Figure 18.43** shows the charge distribution in a water molecule, which is called a polar molecule because it has an inherent separation of charge. Given water's polar character, explain what effect humidity has on removing excess charge from objects.

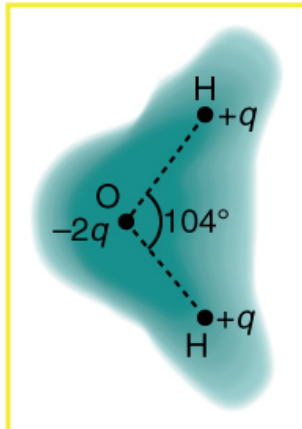

Figure 18.43 Schematic representation of the outer electron cloud of a neutral water molecule. The electrons spend more time near the oxygen than the hydrogens, giving a permanent charge separation as shown. Water is thus a *polar molecule*. It is more easily affected by electrostatic forces than molecules with uniform charge distributions.

10. Using **Figure 18.43**, explain, in terms of Coulomb's law, why a polar molecule (such as in **Figure 18.43**) is attracted by both positive and negative charges.

11. Given the polar character of water molecules, explain how ions in the air form nucleation centers for rain droplets.

18.4 Electric Field: Concept of a Field Revisited

12. Why must the test charge q in the definition of the electric field be vanishingly small?

13. Are the direction and magnitude of the Coulomb force unique at a given point in space? What about the electric field?

18.5 Electric Field Lines: Multiple Charges

14. Compare and contrast the Coulomb force field and the electric field. To do this, make a list of five properties for the Coulomb force field analogous to the five properties listed for electric field lines. Compare each item in your list of Coulomb force field properties with those of the electric field—are they the same or different? (For example, electric field lines cannot cross. Is the same true for Coulomb field lines?)

15. **Figure 18.44** shows an electric field extending over three regions, labeled I, II, and III. Answer the following questions. (a) Are there any isolated charges? If so, in what region and what are their signs? (b) Where is the field strongest? (c) Where is the field weakest? (d) Where is the field the most uniform?

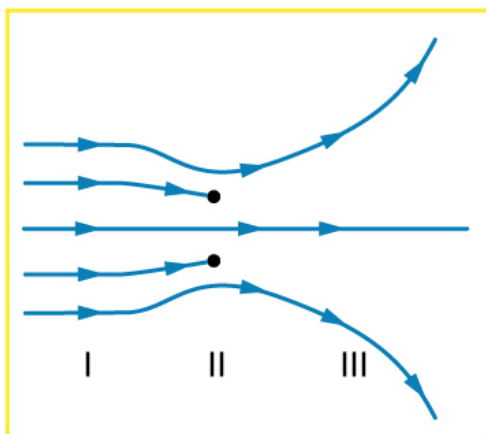

Figure 18.44

18.6 Electric Forces in Biology

16. A cell membrane is a thin layer enveloping a cell. The thickness of the membrane is much less than the size of the cell. In a static situation the membrane has a charge distribution of $-2.5 \times 10^{-6} \text{ C/m}^2$ on its inner surface and $+2.5 \times 10^{-6} \text{ C/m}^2$ on its

outer surface. Draw a diagram of the cell and the surrounding cell membrane. Include on this diagram the charge distribution and the corresponding electric field. Is there any electric field inside the cell? Is there any electric field outside the cell?

18.7 Conductors and Electric Fields in Static Equilibrium

17. Is the object in **Figure 18.45** a conductor or an insulator? Justify your answer.

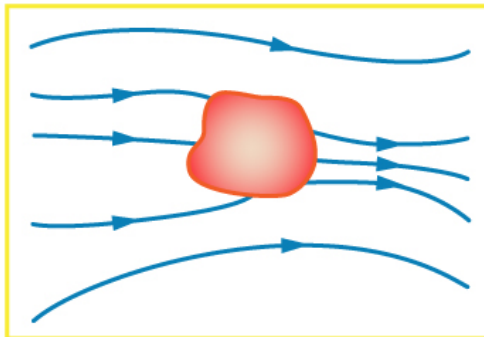

Figure 18.45

18. If the electric field lines in the figure above were perpendicular to the object, would it necessarily be a conductor? Explain.

19. The discussion of the electric field between two parallel conducting plates, in this module states that edge effects are less important if the plates are close together. What does close mean? That is, is the actual plate separation crucial, or is the ratio of plate separation to plate area crucial?

20. Would the self-created electric field at the end of a pointed conductor, such as a lightning rod, remove positive or negative charge from the conductor? Would the same sign charge be removed from a neutral pointed conductor by the application of a similar externally created electric field? (The answers to both questions have implications for charge transfer utilizing points.)

21. Why is a golfer with a metal club over her shoulder vulnerable to lightning in an open fairway? Would she be any safer under a tree?

22. Can the belt of a Van de Graaff accelerator be a conductor? Explain.

23. Are you relatively safe from lightning inside an automobile? Give two reasons.

24. Discuss pros and cons of a lightning rod being grounded versus simply being attached to a building.

25. Using the symmetry of the arrangement, show that the net Coulomb force on the charge q at the center of the square below (**Figure 18.46**) is zero if the charges on the four corners are exactly equal.

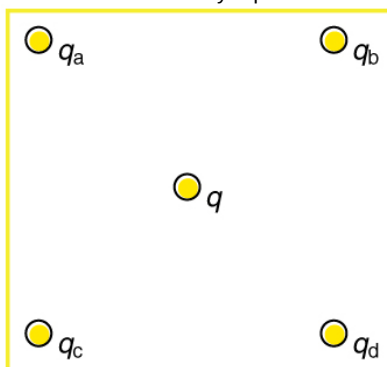

Figure 18.46 Four point charges q_a , q_b , q_c , and q_d lie on the corners of a square and q is located at its center.

26. (a) Using the symmetry of the arrangement, show that the electric field at the center of the square in **Figure 18.46** is zero if the charges on the four corners are exactly equal. (b) Show that this is also true for any combination of charges in which $q_a = q_d$ and $q_b = q_c$

27. (a) What is the direction of the total Coulomb force on q in **Figure 18.46** if q is negative, $q_a = q_c$ and both are negative, and $q_b = q_d$ and both are positive? (b) What is the direction of the electric field at the center of the square in this situation?

28. Considering **Figure 18.46**, suppose that $q_a = q_d$ and $q_b = q_c$. First show that q is in static equilibrium. (You may neglect the gravitational force.) Then discuss whether the equilibrium is stable or unstable, noting that this may depend on the signs of the charges and the direction of displacement of q from the center of the square.

29. If $q_a = 0$ in **Figure 18.46**, under what conditions will there be no net Coulomb force on q ?
30. In regions of low humidity, one develops a special “grip” when opening car doors, or touching metal door knobs. This involves placing as much of the hand on the device as possible, not just the ends of one’s fingers. Discuss the induced charge and explain why this is done.
31. Tollbooth stations on roadways and bridges usually have a piece of wire stuck in the pavement before them that will touch a car as it approaches. Why is this done?
32. Suppose a woman carries an excess charge. To maintain her charged status can she be standing on ground wearing just any pair of shoes? How would you discharge her? What are the consequences if she simply walks away?

Problems & Exercises

18.1 Static Electricity and Charge: Conservation of Charge

- Common static electricity involves charges ranging from nanocoulombs to microcoulombs. (a) How many electrons are needed to form a charge of -2.00 nC (b) How many electrons must be removed from a neutral object to leave a net charge of $0.500 \mu\text{C}$?
- If 1.80×10^{20} electrons move through a pocket calculator during a full day's operation, how many coulombs of charge moved through it?
- To start a car engine, the car battery moves 3.75×10^{21} electrons through the starter motor. How many coulombs of charge were moved?
- A certain lightning bolt moves 40.0 C of charge. How many fundamental units of charge $|q_e|$ is this?

18.2 Conductors and Insulators

- Suppose a speck of dust in an electrostatic precipitator has 1.0000×10^{12} protons in it and has a net charge of -5.00 nC (a very large charge for a small speck). How many electrons does it have?
- An amoeba has 1.00×10^{16} protons and a net charge of 0.300 pC . (a) How many fewer electrons are there than protons? (b) If you paired them up, what fraction of the protons would have no electrons?
- A 50.0 g ball of copper has a net charge of $2.00 \mu\text{C}$.
What fraction of the copper's electrons has been removed? (Each copper atom has 29 protons, and copper has an atomic mass of 63.5.)
- What net charge would you place on a 100 g piece of sulfur if you put an extra electron on 1 in 10^{12} of its atoms? (Sulfur has an atomic mass of 32.1.)
- How many coulombs of positive charge are there in 4.00 kg of plutonium, given its atomic mass is 244 and that each plutonium atom has 94 protons?

18.3 Coulomb's Law

- What is the repulsive force between two pith balls that are 8.00 cm apart and have equal charges of -30.0 nC ?
- (a) How strong is the attractive force between a glass rod with a $0.700 \mu\text{C}$ charge and a silk cloth with a $-0.600 \mu\text{C}$ charge, which are 12.0 cm apart, using the approximation that they act like point charges? (b) Discuss how the answer to this problem might be affected if the charges are distributed over some area and do not act like point charges.
- Two point charges exert a 5.00 N force on each other. What will the force become if the distance between them is increased by a factor of three?
- Two point charges are brought closer together, increasing the force between them by a factor of 25. By what factor was their separation decreased?

- How far apart must two point charges of 75.0 nC (typical of static electricity) be to have a force of 1.00 N between them?
- If two equal charges each of 1 C each are separated in air by a distance of 1 km , what is the magnitude of the force acting between them? You will see that even at a distance as large as 1 km , the repulsive force is substantial because 1 C is a very significant amount of charge.
- A test charge of $+2 \mu\text{C}$ is placed halfway between a charge of $+6 \mu\text{C}$ and another of $+4 \mu\text{C}$ separated by 10 cm . (a) What is the magnitude of the force on the test charge? (b) What is the direction of this force (away from or toward the $+6 \mu\text{C}$ charge)?
- Bare free charges do not remain stationary when close together. To illustrate this, calculate the acceleration of two isolated protons separated by 2.00 nm (a typical distance between gas atoms). Explicitly show how you follow the steps in the Problem-Solving Strategy for electrostatics.
- (a) By what factor must you change the distance between two point charges to change the force between them by a factor of 10? (b) Explain how the distance can either increase or decrease by this factor and still cause a factor of 10 change in the force.
- Suppose you have a total charge q_{tot} that you can split in any manner. Once split, the separation distance is fixed. How do you split the charge to achieve the greatest force?
- (a) Common transparent tape becomes charged when pulled from a dispenser. If one piece is placed above another, the repulsive force can be great enough to support the top piece's weight. Assuming equal point charges (only an approximation), calculate the magnitude of the charge if electrostatic force is great enough to support the weight of a 10.0 mg piece of tape held 1.00 cm above another. (b) Discuss whether the magnitude of this charge is consistent with what is typical of static electricity.
- (a) Find the ratio of the electrostatic to gravitational force between two electrons. (b) What is this ratio for two protons? (c) Why is the ratio different for electrons and protons?
- At what distance is the electrostatic force between two protons equal to the weight of one proton?
- A certain five cent coin contains 5.00 g of nickel. What fraction of the nickel atoms' electrons, removed and placed 1.00 m above it, would support the weight of this coin? The atomic mass of nickel is 58.7, and each nickel atom contains 28 electrons and 28 protons.
- (a) Two point charges totaling $8.00 \mu\text{C}$ exert a repulsive force of 0.150 N on one another when separated by 0.500 m . What is the charge on each? (b) What is the charge on each if the force is attractive?
- Point charges of $5.00 \mu\text{C}$ and $-3.00 \mu\text{C}$ are placed 0.250 m apart. (a) Where can a third charge be placed so that the net force on it is zero? (b) What if both charges are positive?
- Two point charges q_1 and q_2 are 3.00 m apart, and their total charge is $20 \mu\text{C}$. (a) If the force of repulsion between them is 0.075 N , what are magnitudes of the two charges? (b) If one charge attracts the other with a force of 0.525 N , what are the magnitudes of the two charges? Note

that you may need to solve a quadratic equation to reach your answer.

18.4 Electric Field: Concept of a Field Revisited

27. What is the magnitude and direction of an electric field that exerts a 2.00×10^{-5} N upward force on a $-1.75 \mu\text{C}$ charge?
28. What is the magnitude and direction of the force exerted on a $3.50 \mu\text{C}$ charge by a 250 N/C electric field that points due east?
29. Calculate the magnitude of the electric field 2.00 m from a point charge of 5.00 mC (such as found on the terminal of a Van de Graaff).
30. (a) What magnitude point charge creates a 10,000 N/C electric field at a distance of 0.250 m? (b) How large is the field at 10.0 m?
31. Calculate the initial (from rest) acceleration of a proton in a 5.00×10^6 N/C electric field (such as created by a research Van de Graaff). Explicitly show how you follow the steps in the Problem-Solving Strategy for electrostatics.
32. (a) Find the direction and magnitude of an electric field that exerts a 4.80×10^{-17} N westward force on an electron. (b) What magnitude and direction force does this field exert on a proton?

18.5 Electric Field Lines: Multiple Charges

33. (a) Sketch the electric field lines near a point charge $+q$. (b) Do the same for a point charge $-3.00q$.
34. Sketch the electric field lines a long distance from the charge distributions shown in **Figure 18.26** (a) and (b)
35. **Figure 18.47** shows the electric field lines near two charges q_1 and q_2 . What is the ratio of their magnitudes? (b) Sketch the electric field lines a long distance from the charges shown in the figure.

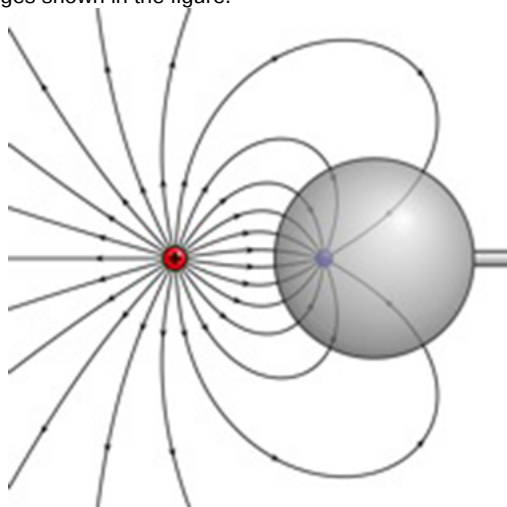

Figure 18.47 The electric field near two charges.

36. Sketch the electric field lines in the vicinity of two opposite charges, where the negative charge is three times greater in magnitude than the positive. (See **Figure 18.47** for a similar situation).

18.7 Conductors and Electric Fields in Static Equilibrium

37. Sketch the electric field lines in the vicinity of the conductor in **Figure 18.48** given the field was originally uniform and parallel to the object's long axis. Is the resulting field small near the long side of the object?



Figure 18.48

38. Sketch the electric field lines in the vicinity of the conductor in **Figure 18.49** given the field was originally uniform and parallel to the object's long axis. Is the resulting field small near the long side of the object?



Figure 18.49

39. Sketch the electric field between the two conducting plates shown in **Figure 18.50**, given the top plate is positive and an equal amount of negative charge is on the bottom plate. Be certain to indicate the distribution of charge on the plates.

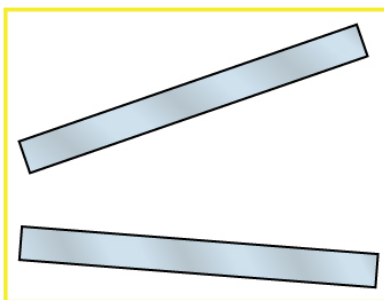

Figure 18.50

40. Sketch the electric field lines in the vicinity of the charged insulator in **Figure 18.51** noting its nonuniform charge distribution.

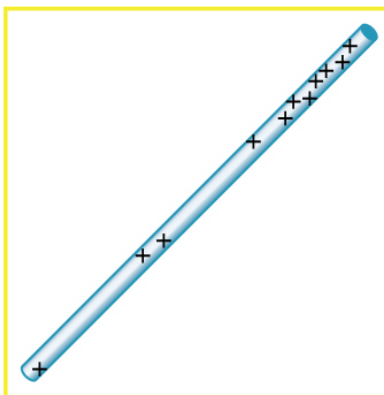

Figure 18.51 A charged insulating rod such as might be used in a classroom demonstration.

41. What is the force on the charge located at $x = 8.00$ cm in **Figure 18.52(a)** given that $q = 1.00 \mu\text{C}$?

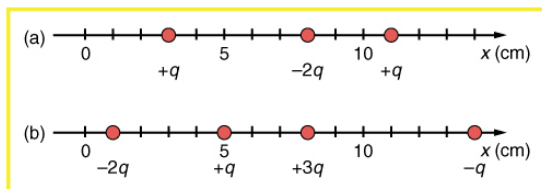

Figure 18.52 (a) Point charges located at 3.00, 8.00, and 11.0 cm along the x -axis. (b) Point charges located at 1.00, 5.00, 8.00, and 14.0 cm along the x -axis.

42. (a) Find the total electric field at $x = 1.00$ cm in **Figure 18.52(b)** given that $q = 5.00$ nC. (b) Find the total electric field at $x = 11.00$ cm in **Figure 18.52(b)**. (c) If the charges are allowed to move and eventually be brought to rest by friction, what will the final charge configuration be? (That is, will there be a single charge, double charge, etc., and what will its value(s) be?)

43. (a) Find the electric field at $x = 5.00$ cm in **Figure 18.52(a)**, given that $q = 1.00 \mu\text{C}$. (b) At what position between 3.00 and 8.00 cm is the total electric field the same as that for $-2q$ alone? (c) Can the electric field be zero anywhere between 0.00 and 8.00 cm? (d) At very large positive or negative values of x , the electric field approaches zero in both (a) and (b). In which does it most rapidly approach zero and why? (e) At what position to the right of 11.0 cm is the total electric field zero, other than at infinity? (Hint: A graphing calculator can yield considerable insight in this problem.)

44. (a) Find the total Coulomb force on a charge of 2.00 nC located at $x = 4.00$ cm in **Figure 18.52(b)**, given that $q = 1.00 \mu\text{C}$. (b) Find the x -position at which the electric field is zero in **Figure 18.52(b)**.

45. Using the symmetry of the arrangement, determine the direction of the force on q in the figure below, given that $q_a = q_b = +7.50 \mu\text{C}$ and $q_c = q_d = -7.50 \mu\text{C}$. (b) Calculate the magnitude of the force on the charge q , given that the square is 10.0 cm on a side and $q = 2.00 \mu\text{C}$.

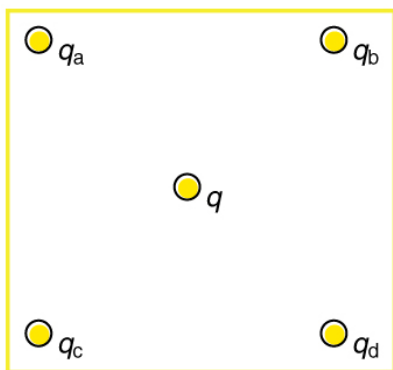

Figure 18.53

46. (a) Using the symmetry of the arrangement, determine the direction of the electric field at the center of the square in **Figure 18.53**, given that $q_a = q_b = -1.00 \mu\text{C}$ and $q_c = q_d = +1.00 \mu\text{C}$. (b) Calculate the magnitude of the electric field at the location of q , given that the square is 5.00 cm on a side.

47. Find the electric field at the location of q_a in **Figure 18.53** given that $q_b = q_c = q_d = +2.00$ nC, $q = -1.00$ nC, and the square is 20.0 cm on a side.

48. Find the total Coulomb force on the charge q in **Figure 18.53**, given that $q = 1.00 \mu\text{C}$, $q_a = 2.00 \mu\text{C}$, $q_b = -3.00 \mu\text{C}$, $q_c = -4.00 \mu\text{C}$, and $q_d = +1.00 \mu\text{C}$. The square is 50.0 cm on a side.

49. (a) Find the electric field at the location of q_a in **Figure 18.54**, given that $q_b = +10.00 \mu\text{C}$ and $q_c = -5.00 \mu\text{C}$. (b) What is the force on q_a , given that $q_a = +1.50$ nC?

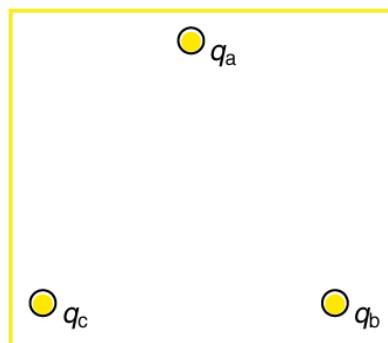

Figure 18.54 Point charges located at the corners of an equilateral triangle 25.0 cm on a side.

50. (a) Find the electric field at the center of the triangular configuration of charges in **Figure 18.54**, given that $q_a = +2.50$ nC, $q_b = -8.00$ nC, and $q_c = +1.50$ nC.

(b) Is there any combination of charges, other than $q_a = q_b = q_c$, that will produce a zero strength electric field at the center of the triangular configuration?

18.8 Applications of Electrostatics

51. (a) What is the electric field 5.00 m from the center of the terminal of a Van de Graaff with a 3.00 mC charge, noting that the field is equivalent to that of a point charge at the center of the terminal? (b) At this distance, what force does the field exert on a $2.00 \mu\text{C}$ charge on the Van de Graaff's belt?

52. (a) What is the direction and magnitude of an electric field that supports the weight of a free electron near the surface of Earth? (b) Discuss what the small value for this field implies regarding the relative strength of the gravitational and electrostatic forces.

53. A simple and common technique for accelerating electrons is shown in **Figure 18.55**, where there is a uniform electric field between two plates. Electrons are released, usually from a hot filament, near the negative plate, and there is a small hole in the positive plate that allows the electrons to continue moving. (a) Calculate the acceleration of the

electron if the field strength is $2.50 \times 10^4 \text{ N/C}$. (b) Explain why the electron will not be pulled back to the positive plate once it moves through the hole.

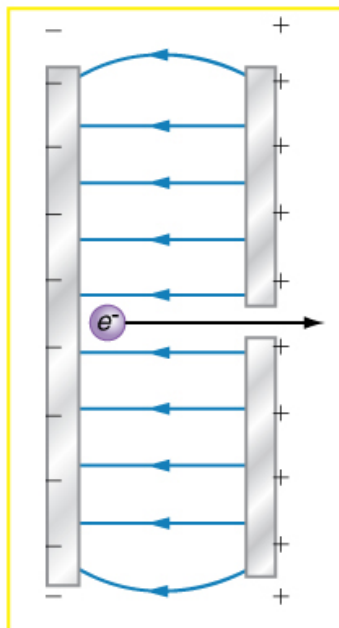

Figure 18.55 Parallel conducting plates with opposite charges on them create a relatively uniform electric field used to accelerate electrons to the right. Those that go through the hole can be used to make a TV or computer screen glow or to produce X-rays.

54. Earth has a net charge that produces an electric field of approximately 150 N/C downward at its surface. (a) What is the magnitude and sign of the excess charge, noting the electric field of a conducting sphere is equivalent to a point charge at its center? (b) What acceleration will the field produce on a free electron near Earth's surface? (c) What mass object with a single extra electron will have its weight supported by this field?

55. Point charges of $25.0 \mu\text{C}$ and $45.0 \mu\text{C}$ are placed 0.500 m apart. (a) At what point along the line between them is the electric field zero? (b) What is the electric field halfway between them?

56. What can you say about two charges q_1 and q_2 , if the electric field one-fourth of the way from q_1 to q_2 is zero?

57. Integrated Concepts

Calculate the angular velocity ω of an electron orbiting a proton in the hydrogen atom, given the radius of the orbit is $0.530 \times 10^{-10} \text{ m}$. You may assume that the proton is stationary and the centripetal force is supplied by Coulomb attraction.

58. Integrated Concepts

An electron has an initial velocity of $5.00 \times 10^6 \text{ m/s}$ in a uniform $2.00 \times 10^5 \text{ N/C}$ strength electric field. The field accelerates the electron in the direction opposite to its initial velocity. (a) What is the direction of the electric field? (b) How far does the electron travel before coming to rest? (c) How long does it take the electron to come to rest? (d) What is the electron's velocity when it returns to its starting point?

59. Integrated Concepts

The practical limit to an electric field in air is about $3.00 \times 10^6 \text{ N/C}$. Above this strength, sparking takes place because air begins to ionize and charges flow, reducing the field. (a) Calculate the distance a free proton must travel in this field to reach 3.00% of the speed of light, starting from rest. (b) Is this practical in air, or must it occur in a vacuum?

60. Integrated Concepts

A 5.00 g charged insulating ball hangs on a 30.0 cm long string in a uniform horizontal electric field as shown in **Figure 18.56**. Given the charge on the ball is $1.00 \mu\text{C}$, find the strength of the field.

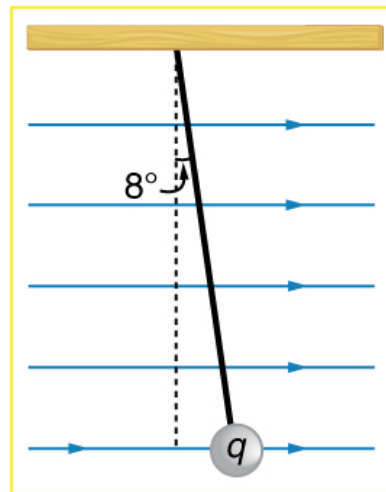

Figure 18.56 A horizontal electric field causes the charged ball to hang at an angle of 8.00° .

61. Integrated Concepts

Figure 18.57 shows an electron passing between two charged metal plates that create an 100 N/C vertical electric field perpendicular to the electron's original horizontal velocity. (These can be used to change the electron's direction, such as in an oscilloscope.) The initial speed of the electron is $3.00 \times 10^6 \text{ m/s}$, and the horizontal distance it travels in the uniform field is 4.00 cm . (a) What is its vertical deflection? (b) What is the vertical component of its final velocity? (c) At what angle does it exit? Neglect any edge effects.

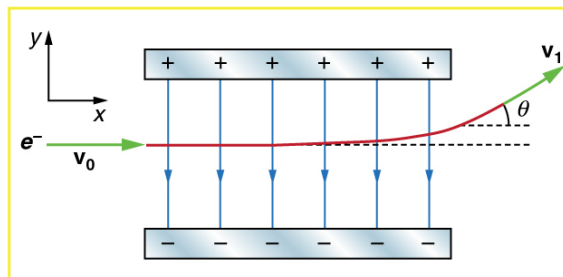

Figure 18.57

62. Integrated Concepts

The classic Millikan oil drop experiment was the first to obtain an accurate measurement of the charge on an electron. In it, oil drops were suspended against the gravitational force by a

vertical electric field. (See **Figure 18.58**.) Given the oil drop to be $1.00\ \mu\text{m}$ in radius and have a density of $920\ \text{kg/m}^3$:

(a) Find the weight of the drop. (b) If the drop has a single excess electron, find the electric field strength needed to balance its weight.

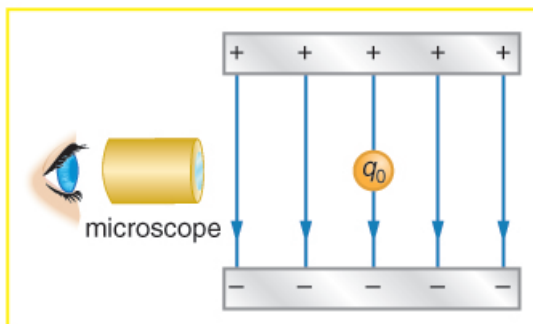

Figure 18.58 In the Millikan oil drop experiment, small drops can be suspended in an electric field by the force exerted on a single excess electron. Classically, this experiment was used to determine the electron charge q_e by measuring the electric field and mass of the drop.

63. Integrated Concepts

(a) In **Figure 18.59**, four equal charges q lie on the corners of a square. A fifth charge Q is on a mass m directly above the center of the square, at a height equal to the length d of one side of the square. Determine the magnitude of q in terms of Q , m , and d , if the Coulomb force is to equal the weight of m . (b) Is this equilibrium stable or unstable? Discuss.

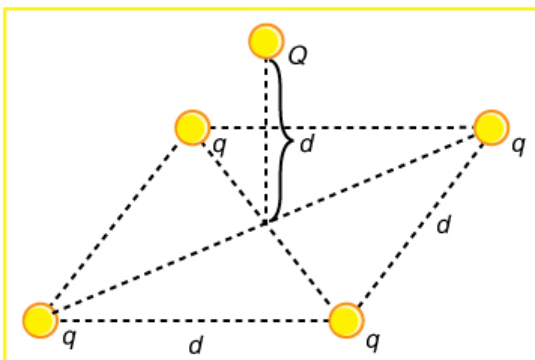

Figure 18.59 Four equal charges on the corners of a horizontal square support the weight of a fifth charge located directly above the center of the square.

64. Unreasonable Results

(a) Calculate the electric field strength near a $10.0\ \text{cm}$ diameter conducting sphere that has $1.00\ \text{C}$ of excess charge on it. (b) What is unreasonable about this result? (c) Which assumptions are responsible?

65. Unreasonable Results

(a) Two $0.500\ \text{g}$ raindrops in a thunderhead are $1.00\ \text{cm}$ apart when they each acquire $1.00\ \text{mC}$ charges. Find their acceleration. (b) What is unreasonable about this result? (c) Which premise or assumption is responsible?

66. Unreasonable Results

A wrecking yard inventor wants to pick up cars by charging a $0.400\ \text{m}$ diameter ball and inducing an equal and opposite charge on the car. If a car has a $1000\ \text{kg}$ mass and the ball is to be able to lift it from a distance of $1.00\ \text{m}$: (a) What minimum charge must be used? (b) What is the electric field near the surface of the ball? (c) Why are these results unreasonable? (d) Which premise or assumption is responsible?

67. Construct Your Own Problem

Consider two insulating balls with evenly distributed equal and opposite charges on their surfaces, held with a certain distance between the centers of the balls. Construct a problem in which you calculate the electric field (magnitude and direction) due to the balls at various points along a line running through the centers of the balls and extending to infinity on either side. Choose interesting points and comment on the meaning of the field at those points. For example, at what points might the field be just that due to one ball and where does the field become negligibly small? Among the things to be considered are the magnitudes of the charges and the distance between the centers of the balls. Your instructor may wish for you to consider the electric field off axis or for a more complex array of charges, such as those in a water molecule.

68. Construct Your Own Problem

Consider identical spherical conducting space ships in deep space where gravitational fields from other bodies are negligible compared to the gravitational attraction between the ships. Construct a problem in which you place identical excess charges on the space ships to exactly counter their gravitational attraction. Calculate the amount of excess charge needed. Examine whether that charge depends on the distance between the centers of the ships, the masses of the ships, or any other factors. Discuss whether this would be an easy, difficult, or even impossible thing to do in practice.

